



PICkitTM 2
Microcontroller Programmer
USER'S GUIDE

Note the following details of the code protection feature on Microchip devices:

- Microchip products meet the specification contained in their particular Microchip Data Sheet.
- Microchip believes that its family of products is one of the most secure families of its kind on the market today, when used in the intended manner and under normal conditions.
- There are dishonest and possibly illegal methods used to breach the code protection feature. All of these methods, to our knowledge, require using the Microchip products in a manner outside the operating specifications contained in Microchip's Data Sheets. Most likely, the person doing so is engaged in theft of intellectual property.
- Microchip is willing to work with the customer who is concerned about the integrity of their code.
- Neither Microchip nor any other semiconductor manufacturer can guarantee the security of their code. Code protection does not mean that we are guaranteeing the product as "unbreakable."

Code protection is constantly evolving. We at Microchip are committed to continuously improving the code protection features of our products. Attempts to break Microchip's code protection feature may be a violation of the Digital Millennium Copyright Act. If such acts allow unauthorized access to your software or other copyrighted work, you may have a right to sue for relief under that Act.

Information contained in this publication regarding device applications and the like is provided only for your convenience and may be superseded by updates. It is your responsibility to ensure that your application meets with your specifications. MICROCHIP MAKES NO REPRESENTATIONS OR WARRANTIES OF ANY KIND WHETHER EXPRESS OR IMPLIED, WRITTEN OR ORAL, STATUTORY OR OTHERWISE, RELATED TO THE INFORMATION, INCLUDING BUT NOT LIMITED TO ITS CONDITION, QUALITY, PERFORMANCE, MERCHANTABILITY OR FITNESS FOR PURPOSE. Microchip disclaims all liability arising from this information and its use. Use of Microchip devices in life support and/or safety applications is entirely at the buyer's risk, and the buyer agrees to defend, indemnify and hold harmless Microchip from any and all damages, claims, suits, or expenses resulting from such use. No licenses are conveyed, implicitly or otherwise, under any Microchip intellectual property rights.

Trademarks

The Microchip name and logo, the Microchip logo, Accuron, dsPIC, KEELOQ, KEELOQ logo, microID, MPLAB, PIC, PICmicro, PICSTART, PRO MATE, rPIC and SmartShunt are registered trademarks of Microchip Technology Incorporated in the U.S.A. and other countries.

AmPLab, FilterLab, Linear Active Thermistor, Migratable Memory, MXDEV, MXLAB, SEEVAL, SmartSensor and The Embedded Control Solutions Company are registered trademarks of Microchip Technology Incorporated in the U.S.A.

Analog-for-the-Digital Age, Application Maestro, CodeGuard, dsPICDEM, dsPICDEM.net, dsPICworks, dsSPEAK, ECAN, ECONOMONITOR, FanSense, FlexROM, fuzzyLAB, In-Circuit Serial Programming, ICSP, ICEPIC, Mindi, MiWi, MPASM, MPLAB Certified logo, MPLIB, MPLINK, PICkit, PICDEM, PICDEM.net, PICLAB, PICtail, PowerCal, PowerInfo, PowerMate, PowerTool, REAL ICE, rLAB, Select Mode, Smart Serial, SmartTel, Total Endurance, UNI/O, WiperLock and ZENA are trademarks of Microchip Technology Incorporated in the U.S.A. and other countries.

SQTP is a service mark of Microchip Technology Incorporated in the U.S.A.

All other trademarks mentioned herein are property of their respective companies.

© 2007, Microchip Technology Incorporated, Printed in the U.S.A., All Rights Reserved.

 Printed on recycled paper.

QUALITY MANAGEMENT SYSTEM
CERTIFIED BY DNV
== ISO/TS 16949:2002 ==

Microchip received ISO/TS-16949:2002 certification for its worldwide headquarters, design and wafer fabrication facilities in Chandler and Tempe, Arizona; Gresham, Oregon and design centers in California and India. The Company's quality system processes and procedures are for its PIC® MCUs and dsPIC® DSCs, KEELOQ® code hopping devices, Serial EEPROMs, microperipherals, nonvolatile memory and analog products. In addition, Microchip's quality system for the design and manufacture of development systems is ISO 9001:2000 certified.



Table of Contents

Preface	1
Chapter 1. PICKit™ 2 Programmer Overview	
1.1 Introduction	7
1.2 Highlights	7
1.3 PICKit™ 2 Microcontroller Programmer Contents	7
1.4 Introducing the PICKit™ 2 Microcontroller Programmer	7
1.5 PICKit™ 2 Microcontroller Programmer Overview	8
1.5.1 USB Port Connection	8
1.5.2 Status LEDs	8
1.5.3 Push Button	8
1.5.4 Programming Connector	9
1.5.5 Lanyard Connection	9
1.6 Programming Software	10
1.6.1 Menu Bar	11
1.6.2 Device Configuration	12
1.6.3 Status Window Bar	12
1.6.4 Progress Bar	12
1.6.5 Device VDD	12
1.6.6 Memory Source	13
1.6.7 Program Memory	13
1.6.8 Data EEPROM Memory	13
Chapter 2. Getting Started	
2.1 Introduction	15
2.2 Installing the PICKit™ 2 Programming Software	15
2.3 Using the PICKit™ 2 Programming Software	15
2.3.1 Connecting to the Device	16
2.3.2 Device Identification	16
2.3.3 Target Power	17
2.3.4 Import HEX File	18
2.3.5 Write	19
2.3.6 Automatic File Reload	20
2.3.7 Verify	20
2.3.8 Read	21
2.3.9 Code-Protect Device	21
2.3.10 Erase	21
2.3.11 Blank Check	22
2.3.12 Auto Import Hex + Write Device Button.....	22
2.3.13 Read Device + Export Hex File Button.....	23

PICKit™ 2 MCU Programmer User's Guide

Chapter 3. PICKit™ 2 Programmer and ICSP™

3.1 Introduction	25
3.2 Isolate VPP/MCLR/Port Pin	26
3.2.1 If the VPP pin is used as a MCLR pin.....	26
3.2.2 If the VPP pin is used as an I/O port pin	26
3.3 Isolate ICSPCLK or PGC and ICSPDAT or PGD pins	26
3.4 VDD	27
3.4.1 The application circuit is powered by the PICKit™ 2 Microcontroller Programmer	27
3.4.2 The application circuit is powered externally	27
3.4.3 Bulk Erase is used	27
3.5 Vss	28
3.6 Other Considerations	28

Chapter 4. PICKit™ 2 Debug Express

4.1 Introduction	29
4.1.1 Supported Devices	29
4.1.2 Resources Used by PICKit™ 2 Debug Express	29
4.2 PICKit™ 2 Debug Express	30
4.2.1 Selecting the Device and Development Mode	30
4.2.2 PICKit™ 2 Microcontroller Programmer Debug Tool	31
4.2.3 Updating PICKit™ 2 Programmer Operating System	33
4.2.4 Running the Project Wizard	33
4.2.5 PIC16887 Debug Demo Project	36
4.2.6 Creating a Hex File	37
4.2.7 Setting Debug Options	38
4.2.8 Loading Program Code for Debugging	39
4.2.9 PIC16F887 Debug Demo	40
4.2.10 Debugging the PIC16F887 Debug Demo Code	41
4.2.11 Programming the Application	44

Chapter 5. Troubleshooting

5.1 Introduction	47
5.2 Frequently Asked Questions	47

Chapter 6. Updating the PICKit™ 2 Programmer Operating System

6.1 Introduction	49
6.2 Updating the PICKit™ 2 Microcontroller Programmer	49

Appendix A. Hardware Schematics

A.1 Introduction	51
------------------------	----

Worldwide Sales and Service	54
--	-----------



Preface

NOTICE TO CUSTOMERS

All documentation becomes dated, and this manual is no exception. Microchip tools and documentation are constantly evolving to meet customer needs, so some actual dialogs and/or tool descriptions may differ from those in this document. Please refer to our web site (www.microchip.com) to obtain the latest documentation available.

Documents are identified with a “DS” number. This number is located on the bottom of each page, in front of the page number. The numbering convention for the DS number is “DSXXXXA”, where “XXXXX” is the document number and “A” is the revision level of the document.

For the most up-to-date information on development tools, see the MPLAB® IDE on-line help. Select the Help menu, and then Topics to open a list of available on-line help files.

INTRODUCTION

This chapter contains general information that will be useful to know before using the PICKit™ 2 Microcontroller Programmer. Items discussed in this chapter include:

- Document Layout
- Conventions Used in this Guide
- Warranty Registration
- Recommended Reading
- The Microchip Web Site
- Development Systems Customer Change Notification Service
- Customer Support
- Document Revision History

PICKit™ 2 MCU Programmer User's Guide

DOCUMENT LAYOUT

This document describes how to use the PICKit™ 2 Microcontroller Programmer as a development tool to emulate and debug firmware on a target board. The manual layout is as follows:

- **Chapter 1. “PICKit™ 2 Programmer Overview”** – Provides an overview of the PICKit™ 2 Microcontroller Programmer.
- **Chapter 2. “Getting Started”** – Provides Instructions on how to get started using the PICKit™ 2 Microcontroller Programmer to program Flash-based PIC® Microcontroller Units (MCUs).
- **Chapter 3. “PICKit™ 2 Programmer and ICSP™”** – Describes programming with the PICKit™ 2 Microcontroller Programmer using In-Circuit Serial Programming™ (ICSP™).
- **Chapter 4. “PICKit™ 2 Debug Express”** – Provides a tutorial on using the PICKit™ 2 Debug Express debugger program.
- **Chapter 5. “Troubleshooting”** – Provides information on solving common problems.
- **Chapter 6. “Updating the PICKit™ 2 Programmer Operating System”** – Provides instruction on how to update your PICKit™ 2 Microcontroller Programmer's Operating System.
- **Appendix A. “Hardware Schematics”** – Illustrates the PICKit™ 2 Microcontroller Programmer hardware schematic diagrams.

CONVENTIONS USED IN THIS GUIDE

This manual uses the following documentation conventions:

DOCUMENTATION CONVENTIONS

Description	Represents	Examples
Arial font:		
Italic characters	Referenced books	<i>MPLAB[®] IDE User's Guide</i>
	Emphasized text	...is the <i>only</i> compiler...
Initial caps	A window	the Output window
	A dialog	the Settings dialog
	A menu selection	select Enable Programmer
Quotes	A field name in a window or dialog	"Save project before build"
Underlined, italic text with right angle bracket	A menu path	<u><i>File>Save</i></u>
Bold characters	A dialog button	Click OK
	A tab	Click the Power tab
N'Rnnnn	A number in verilog format, where N is the total number of digits, R is the radix and n is a digit.	4'b0010, 2'hF1
Text in angle brackets < >	A key on the keyboard	Press <Enter>, <F1>
Courier New font:		
Plain Courier New	Sample source code	#define START
	Filenames	autoexec.bat
	File paths	c:\mcc18\h
	Keywords	_asm, _endasm, static
	Command-line options	-Opa+, -Opa-
	Bit values	0, 1
	Constants	0xFF, 'A'
Italic Courier New	A variable argument	<i>file.o</i> , where <i>file</i> can be any valid filename
Square brackets []	Optional arguments	mcc18 [options] <i>file</i> [options]
Curly brackets and pipe character: { }	Choice of mutually exclusive arguments; an OR selection	errorlevel {0 1}
Ellipses...	Replaces repeated text	var_name [, var_name...]
	Represents code supplied by user	void main (void) { ... }

PICKit™ 2 MCU Programmer User's Guide

WARRANTY REGISTRATION

Please complete the enclosed Warranty Registration Card and mail it promptly. Sending in the Warranty Registration Card entitles users to receive new product updates. Interim software releases are available at the Microchip web site.

RECOMMENDED READING

This user's guide describes how to use PICKit™ 2 Microcontroller Programmer. Other useful documents are listed below. The following Microchip documents are available and recommended as supplemental reference resources.

44-Pin Demo Board User's Guide (DS41296)

Consult this document for instructions on how to use the 44-Pin Demo Board as a development tool to emulate and debug firmware on a target board.

PICKit™ 2 Low Pin Count Demo Board User's Guide (DS51556)

Consult this document for instructions on how to use Microchip Technology's Low Pin Count device (8-pin, 14-pin and 20-pin). This document includes a series of tutorials.

MPLAB® IDE User's Guide (DS51519)

Consult this document for more information pertaining to the installation and features of the MPLAB® Integrated Development Environment (IDE) software.

MPLAB® IDE Quick Start Guide (DS51281)

Describes how to set up the MPLAB® IDE software and use it to create projects and program devices.

MPLAB® IDE On-line Help

In-Circuit Serial Programmer™(ICSP™) Guide (DS30277)

This document contains helpful design guidelines for successful ICSP programming. It includes application notes on hardware designs and the ICSP programming specifications.

MPASM™ Assembler, MPLINK™ Object Linker, MPLIB™ Object Librarian User's Guide (DS33014)

Describes how to use the Microchip PIC® MCU assembler (MPASM assembler), linker (MPLINK linker), and librarian (MPLIB librarian).

README for PICKit™ 2 Debug Express

For the latest information on using the PICKit™ 2 Debug Express, read the "Readme for PICKit 2.htm" file (an ASCII text file) in the Readmes subdirectory of the MPLAB® IDE installation directory. The Readme file contains updated information and known issues that may not be included in this user's guide.

Readme Files

For the latest information on using other tools, read the tool-specific Readme files in the Readmes subdirectory of the MPLAB® IDE installation directory. The Readme files contain update information and known issues that may not be included in this user's guide.

THE MICROCHIP WEB SITE

Microchip provides online support via our web site at www.microchip.com. This web site is used as a means to make files and information easily available to customers. Accessible by using your favorite Internet browser, the web site contains the following information:

- **Product Support** – Data sheets and errata, application notes and sample programs, design resources, user's guides and hardware support documents, latest software releases and archived software
- **General Technical Support** – Frequently Asked Questions (FAQs), technical support requests, online discussion groups, Microchip consultant program member listing
- **Business of Microchip** – Product selector and ordering guides, latest Microchip press releases, listing of seminars and events, listings of Microchip sales offices, distributors and factory representatives

DEVELOPMENT SYSTEMS CUSTOMER CHANGE NOTIFICATION SERVICE

Microchip's customer notification service helps keep customers current on Microchip products. Subscribers will receive e-mail notification whenever there are changes, updates, revisions or errata related to a specified product family or development tool of interest.

To register, access the Microchip web site at www.microchip.com, click on Customer Change Notification and follow the registration instructions.

The Development Systems product group categories are:

- **Compilers** – The latest information on Microchip C compilers and other language tools. These include the MPLAB[®] C18 and MPLAB[®] C30 C compilers; MPASM[™] and MPLAB[®] ASM30 assemblers; MPLINK[™] and MPLAB[®] LINK30 object linkers; and MPLIB[™] and MPLAB[®] LIB30 object librarians.
- **Emulators** – The latest information on Microchip in-circuit emulators. This includes the MPLAB[®] ICE 2000 and MPLAB[®] ICE 4000.
- **In-Circuit Debuggers** – The latest information on the Microchip in-circuit debugger, MPLAB[®] ICD 2.
- **MPLAB[®] IDE** – The latest information on Microchip MPLAB[®] IDE, the Windows[®] Integrated Development Environment for development systems tools. This list is focused on the MPLAB[®] IDE, MPLAB[®] SIM simulator, MPLAB[®] IDE Project Manager and general editing and debugging features.
- **Programmers** – The latest information on Microchip programmers. These include the MPLAB[®] PM3 and PRO MATE[®] II device programmers and the PICSTART[®] Plus and PICKit[™] development programmers.

PICKit™ 2 MCU Programmer User's Guide

CUSTOMER SUPPORT

Users of Microchip products can receive assistance through several channels:

- Distributor or Representative
- Local Sales Office
- Field Application Engineer (FAE)
- Technical Support

Customers should contact their distributor, representative or field application engineer (FAE) for support. Local sales offices are also available to help customers. A listing of sales offices and locations is included in the back of this document.

Technical support is available through the web site at: <http://support.microchip.com>

DOCUMENT REVISION HISTORY

Revision A (July 2005)

- Initial release of this document.

Revision B (August 2006)

- Updated Preface, added **Chapter 4. "PICKit™ 2 Debug Express"** tutorial.

Revision C (January 2007)

- Updated Chapters 1-6.
- Updated Preface by removing Development Systems Information Line from Customer Support bulleted list.

Revision D (August 2007)

- Updated Appendix A.1 and A.2



Chapter 1. PICKit™ 2 Programmer Overview

1.1 INTRODUCTION

This chapter introduces the PICKit™ 2 Microcontroller Programmer and describes the PICKit™ 2 Microcontroller Programmer features and menu functions.

1.2 HIGHLIGHTS

This chapter discusses:

- The PICKit™ 2 Microcontroller Programmer Contents
- The PICKit™ 2 Microcontroller Programmer Overview
- PICKit™ 2 Programming Software

1.3 PICKit™ 2 MICROCONTROLLER PROGRAMMER CONTENTS

The PICKit™ 2 Microcontroller Programmer Kit contains the following items:

1. The PICKit™ 2 Microcontroller Programmer
2. USB cable
3. PICKit™ Starter Kit CD-ROM

1.4 INTRODUCING THE PICKit™ 2 MICROCONTROLLER PROGRAMMER

The PICKit™ 2 Microcontroller Programmer is a low-cost development programmer. It is capable of programming most of Microchip's Flash microcontrollers. For specific products supported, see the README file included on the PICKit™ Starter Kit CD-ROM.

The PICKit™ 2 Microcontroller Programmer Operating System (firmware) can be easily upgraded from the programming software. New device support can be added by updating the operating system. The latest firmware is available on Microchip's web site, www.microchip.com.

Note: The PICKit™ 2 Microcontroller Programmer is intended for development programming. For production programming, please consider the MPLAB® PM3 Programmer or other third party programmers designed for the production environment.

PICKit™ 2 MCU Programmer User's Guide

1.5 PICKit™ 2 MICROCONTROLLER PROGRAMMER OVERVIEW

The PICKit™ 2 Microcontroller Programmer overview is shown in Figure 1-1.

FIGURE 1-1: PICKit™ 2 MICROCONTROLLER PROGRAMMER

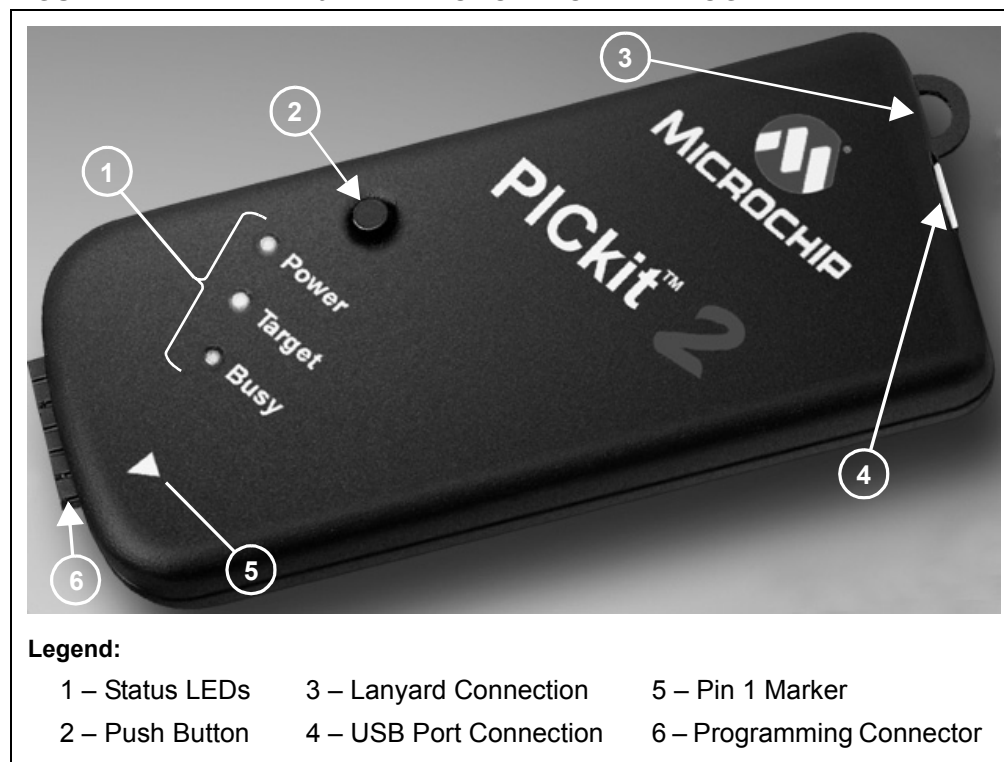

1.5.1 USB Port Connection

The USB Port Connection is a USB mini-B connector. Connect the PICKit™ 2 Microcontroller Programmer to the PC using the supplied USB cable.

1.5.2 Status LEDs

The Status LEDs indicate the status of the PICKit™ 2 Microcontroller Programmer.

1. **Power** (green) – Power is applied to the PICKit™ 2 Microcontroller Programmer via the USB port.
2. **Target** (yellow) – The PICKit™ 2 Microcontroller Programmer is powering the target device.
3. **Busy** (red) – The PICKit™ 2 Microcontroller Programmer is busy with a function such as Program mode or is alerting that a function is in progress.

1.5.3 Push Button

The push button may be used to initiate the Write Device programming function when *Programmer > Write on PICKit Button* is checked.

PICkit™ 2 Programmer Overview

1.5.4 Programming Connector

The programming connector is a 6-pin header (0.100" spacing) that connects to the target device. See the pinout specification in Figure 1-2.

For more information on how to use the PICkit™ 2 Microcontroller Programmer with In-Circuit Serial Programming™ (ICSP™), refer to **Chapter 3. "PICkit™ 2 Programmer and ICSP™"**.

FIGURE 1-2: PICkit™ 2 PROGRAMMER CONNECTOR PINOUT

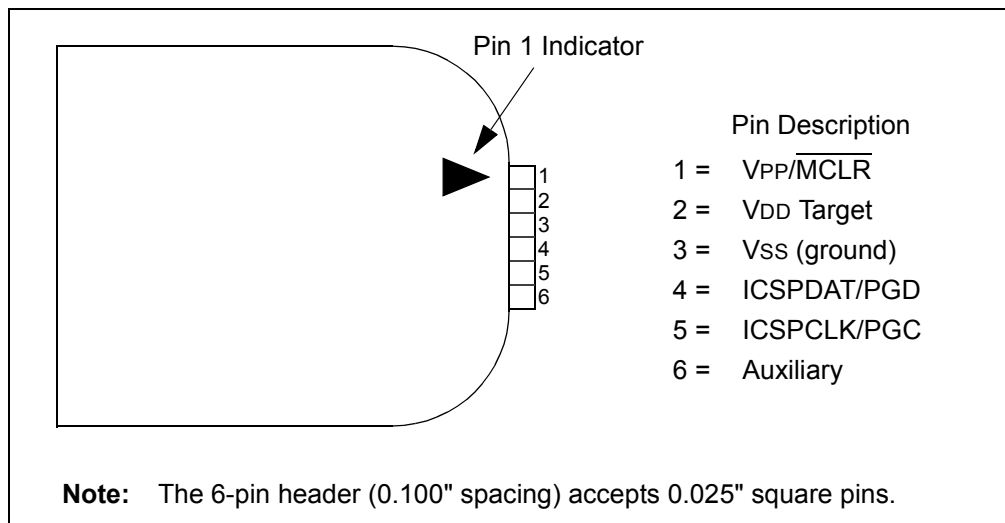

1.5.5 Lanyard Connection

To help prevent possible loss of the The PICkit™ 2 Microcontroller Programmer, a convenient lanyard connection is available on the programmer.

PICKit™ 2 MCU Programmer User's Guide

1.6 PROGRAMMING SOFTWARE

Start the PICKit™ 2 Programming Software by selecting *Start > Programs > Microchip > PICKit 2*. The programming interface appears as shown in Figure 1-3.

For more information on how to use the PICKit™ 2 Programming Software, see **Chapter 2. “Getting Started”**.

Figure 1-3: PICKit™ 2 Programming Software

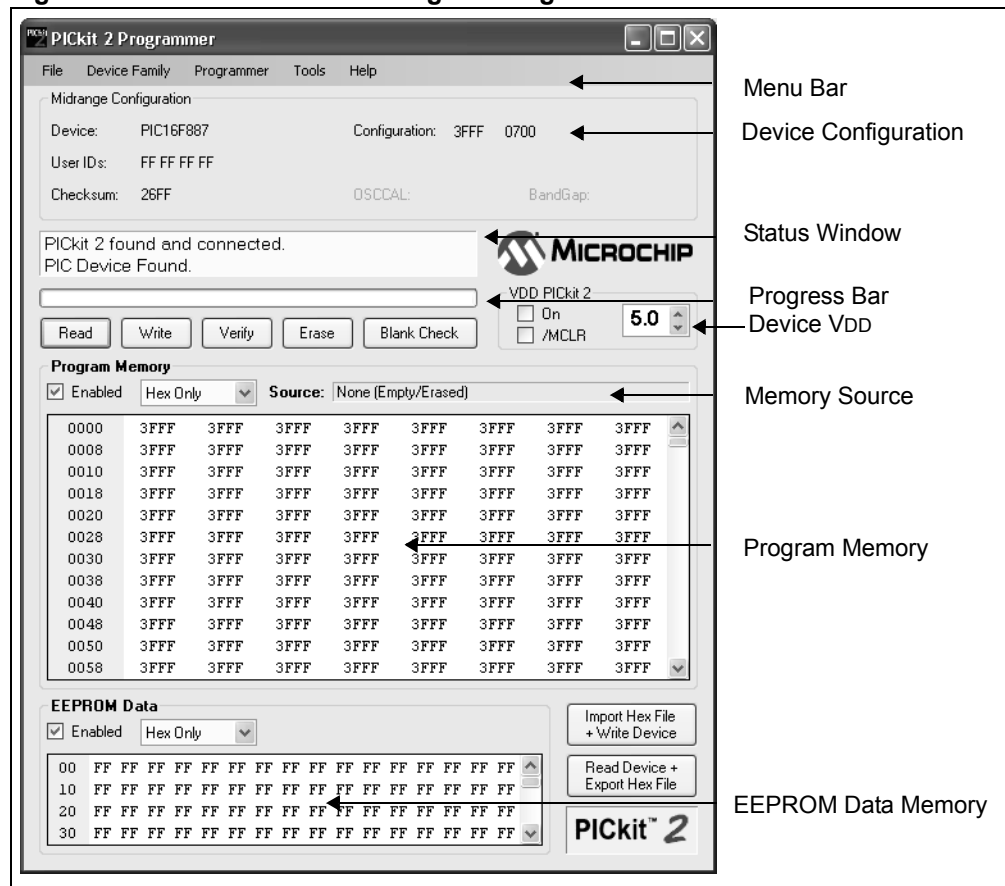

1.6.1 Menu Bar

The menu bar selects various functions of the PICKit™ 2 Programming Software. A summary of the functions are:

FILE

- Import Hex – Import a hex file for programming. The hex file format INHX32 is supported.
- Export Hex – Export a hex file read from a device. The hex file is created in the INHX32 format.
- Exit – Exit the program.

DEVICE FAMILY

Select a device family to search for a connected device in that family. Selecting the device family of the current part will clear all device data.

Some families which cannot be auto-detected (such as Baseline) will bring up a drop down box from which supported devices may be selected.

PROGRAMMER

- Read Device – Reads program memory, data EEPROM memory, ID locations, and Configuration bits.
- Write Device – Writes program memory, data EEPROM memory, ID locations, and Configuration bits.
- Verify – Verifies program memory, data EEPROM memory, ID locations and Configuration bits read from the target MCU against the code stored in the programming software.
- Erase – Performs a bulk erase of the target MCU. OSCCAL and band gap values are preserved on parts with these features.
- Blank Check – Performs a blank check of program memory, data EEPROM memory, ID locations and Configuration bits.
- Verify on Write – When checked, the device will be immediately verified after programming on a Write (recommended). When unchecked, the device will be programmed but not verified on a Write.
- Hold Device in Reset – When checked, the $\overline{\text{MCLR}}$ (V_{PP}) pin is held low (asserted). When unchecked, the pin is released (tri-stated), allowing an external pull-up to bring the device out of Reset.
- Write on PICKit Button – When checked, a Write operation will be initiated by pressing the PICKit 2 button.

TOOLS

- Enable Code Protect – Enables code protection features of the microcontroller on future Write operations.
- Enable Data Protect – Enables data protection feature of microcontrollers with data EEPROM memory on future Write operations.
- Set OSCCAL – Allows the OSCCAL value to be changed for devices where it is stored in the last location of Program Memory.
- Target VDD Source >
 - Auto-Detect – PICKit™ 2 Programmer will automatically detect whether the target device has its own power supply or needs to be powered from by the PICKit™ 2 Programmer on each operation.
 - Force PICKit 2 – PICKit™ 2 Programmer will always attempt to supply VDD to the target device.

PICKit™ 2 MCU Programmer User's Guide

- [Force Target](#) – PICKit™ 2 Programmer will always assume the target has its own power supply.
- [Fast Programming](#) – When checked, PICKit™ 2 Programmer will attempt to program the device as fast as possible. When unchecked, PICKit™ 2 Programmer will slow down ICSP communication. This may be helpful for targets with loaded ICSP lines.
- [Check Communication](#) – Verifies USB communication with the PICKit™ 2 Programmer and ICSP communication with a target device by attempting to identify the connected device by its device ID.
- [Troubleshooting](#) – Opens a wizard to help with troubleshooting connectivity from PICKit™ 2 Programmer to the target device. This is most useful where the PICKit™ 2 Programmer is unable to detect the target device at all.
- [Download PICKit™ 2 Programmer Operating System](#) – Performs a download of the PICKit™ 2 Microcontroller Programmer operating system.

HELP

- [PICKit™ 2 User's Guide](#) – Attempts to launch the PICKit™ 2 User's Guide PDF (Adobe Reader must be installed)
- [44-Pin Demo Board Guide](#) – Attempts to launch the 44-Pin Demo Board User's Guide PDF (Adobe Reader must be installed)
- [LPC Demo Board Guide](#) – Attempts to launch the Low Pin Count Demo Board User's Guide PDF (Adobe Reader must be installed)
- [PICKit™ 2 Programmer on the web](#) – Opens www.microchip.com/pickit2 in the default web browser.
- [Readme](#) – Opens the PICKit™ 2 Readme.txt file.
- [About](#) – Opens a dialog with the PICKit™ 2 Programming Software version, the Device File version, and the PICKit™ 2 Programmer firmware version.

1.6.2 Device Configuration

The Device Configuration window displays the PIC® MCU device, User ID, Configuration Word and Checksum. It also displays OSCCAL and Band Gap for parts with those features.

For baseline (12-bit core) devices, the user must select the device from the Device drop-down menu.

All other part family devices will be detected by their device ID and the part name will be displayed on the Device line.

1.6.3 Status Window

The status window displays text status of the operations in progress. If an operation is successful, the status window will display green background. If an operation fails, the status window will display red. If an operation alerts a caution, the status window will display yellow.

1.6.4 Progress Bar

The progress bar displays the progress of an operation.

1.6.5 Device VDD

The PICKit™ 2 Programmer VDD may be turned on and off by clicking the checkbox "On". The voltage may be set in the box on the right either by typing it directly or using the up/down arrows to adjust it a tenth of a volt at a time. The maximum and minimum allowed voltages will vary depending on the target device.

PICKit™ 2 Programmer Overview

If the “On” checkbox is clear, PICKit™ 2 Programmer will automatically turn on the VDD at the set voltage during any requested programming operation.

FIGURE 1-4: PICKIT™ 2 MICROCONTROLLER PROGRAMMER SUPPLIED VDD

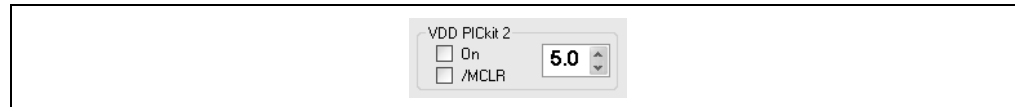

If the target device has its own power supply, then PICKit™ 2 Programmer will display the detected VDD voltage in the box on the right, which will be grayed out to prevent being changed. The checkbox text changes to “check”, and clicking on the checkbox will update the detected VDD voltage value. If *Target VDD > Auto-Detect* is selected, clicking on the checkbox will revert the VDD mode back to PICKit™ 2 Programmer supplied VDD if a target power supply is no longer detected.

FIGURE 1-5: TARGET SUPPLIED VDD

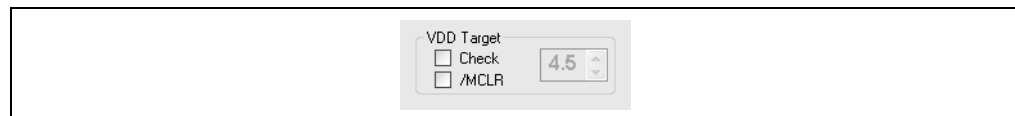

1.6.6 Memory Source

The Source bar displays the source of the currently loaded device data. If read from a hex file it will display the hex file name. If read from a device, it will display the part name. *None* (Empty/Erased) indicates the buffers are empty, and it will display *Edited*. once Program Memory or Data EEPROM Memory has been edited in the window.

1.6.7 Program Memory

Program code can be loaded into the PICKit™ 2 Programming Software from *File > Import HEX* or it can be read from the device by clicking on the **Read** button. The origin of the code is displayed in the Source block. The Program Memory window displays the program code in hexadecimal. The code may be edited in the window.

The check box next to the Program Memory window is only available on devices with EEPROM data memory. If the box is checked, then Program Memory, User IDs, and Configuration Words are written to, read from, and verified on the device. If the box is unchecked, then Program Memory, User IDs, and Configuration Words will not be erased or altered during a Write Device Operation, and will not be read or verified. The checkbox does not affect Erase Device or Blank Check operations. Both memory window checkboxes may not be cleared at the same time.

1.6.8 Data EEPROM Memory

Similar to Program Memory above, program code can be loaded into the PICKit™ 2 Programming Software from *File > Import HEX* or it can be read from the device by clicking on the **Read** button. The origin of the code is displayed in the Source block. The Data EEPROM Memory window displays the program code in hexadecimal. The code may be edited in the window.

The check box next to the EEPROM Data window controls whether the EEPROM Data memory is written, read, and verified. If the box is checked, then the device EEPROM will be overwritten with the window data. If the box is not checked, then the device EEPROM will not be erased or altered during a Write Device operation. The checkbox does not affect Erase Device or Blank Check operations. Both memory window checkboxes may not be cleared at the same time.

PICKit™ 2 MCU Programmer User's Guide

NOTES:



Chapter 2. Getting Started

2.1 INTRODUCTION

This chapter gives instruction on how to get started using the PICKit™ 2 Microcontroller Programmer to program Flash-based PIC® microcontroller units (MCU).

For information on how to use the PICKit™ 2 Microcontroller Programmer with In-Circuit Serial Programming™ (ICSP™), refer to **Chapter 3. “PICKit™ 2 Programmer and ICSP™”**.

For information on how to update the PICKit™ 2 Programmer operating system, refer to **Chapter 6. “Updating the PICKit™ 2 Programmer Operating System”**.

2.2 INSTALLING THE PICKit™ 2 PROGRAMMING SOFTWARE

Insert the PICKit™ Starter Kit CD-ROM into the CD-ROM drive. In a few moments, the introductory screen should be displayed. Follow the directions on the screen for installing the PICKit™ 2 Programming Software.

If the introductory screen does not appear, browse to the CD-ROM directory and select the `AutorunPro.exe` program.

2.3 USING THE PICKit™ 2 PROGRAMMING SOFTWARE

Start the PICKit™ 2 Programming Software by selecting *Start > Programs > Microchip > PICKit 2*. The programming interface appears as shown in Figure 2-1.

FIGURE 2-1: PICKit™ 2 PROGRAMMING SOFTWARE

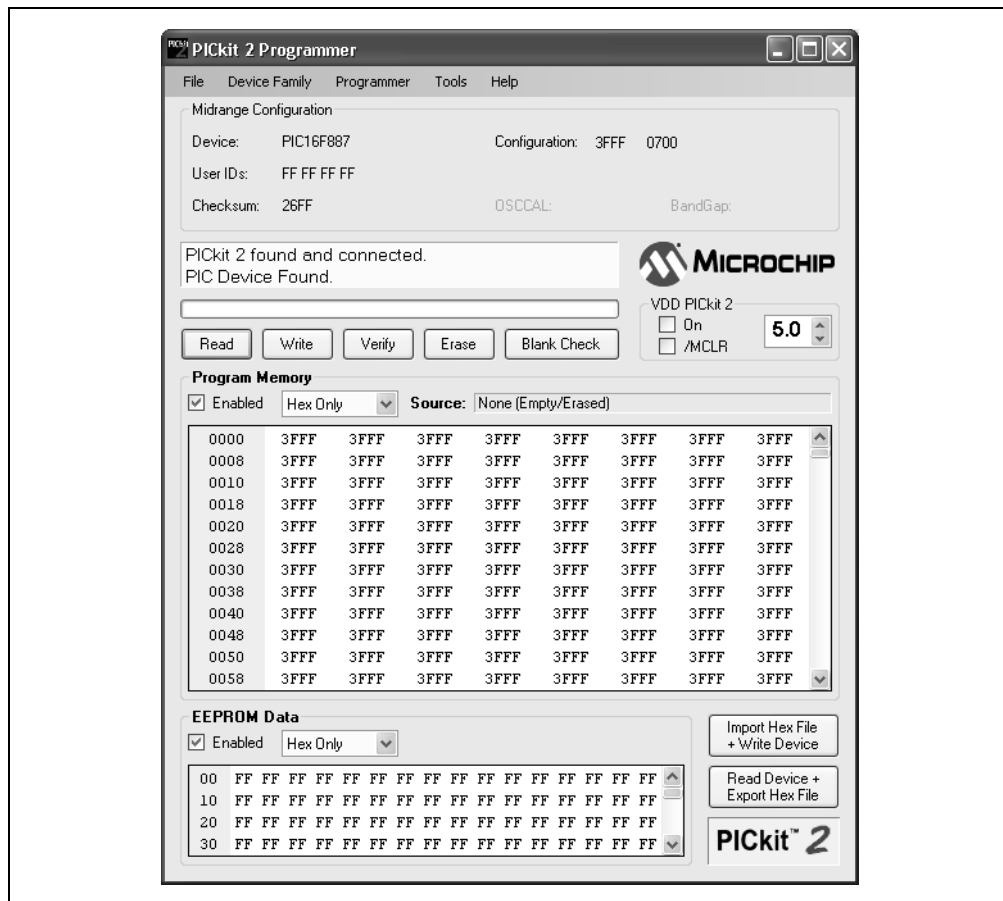

2.3.1 Connecting to the Device

The PICKit™ 2 Microcontroller Programmer is capable of programming a variety of Flash-based Microchip PIC® microcontrollers.

When the PICKit™ 2 Programmer software application is first opened, it will attempt to identify a connected device by the device ID.

To connect to a device once the application is already running, select the device family by clicking on the Device Family menu as shown in Figure 2-2.

FIGURE 2-2: SELECT DEVICE FAMILY

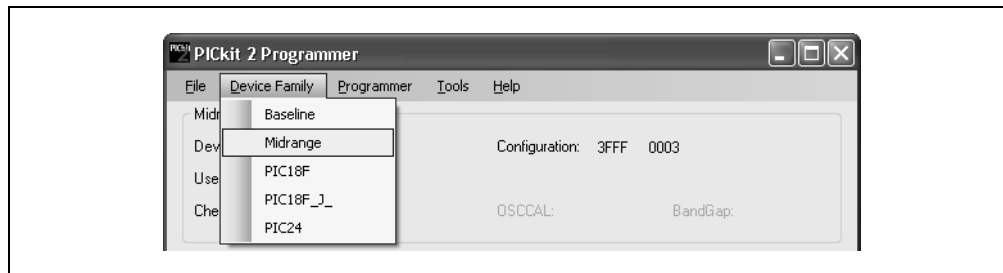

2.3.2 Device Identification

The PICKit™ 2 Microcontroller Programmer will automatically read the device ID word from the connected PIC® MCU and display it in the Configuration window as shown in Figure 2-3. At any time, the device family may be selected to search for connectivity to a device in that family.

FIGURE 2-3: IDENTIFY DEVICE

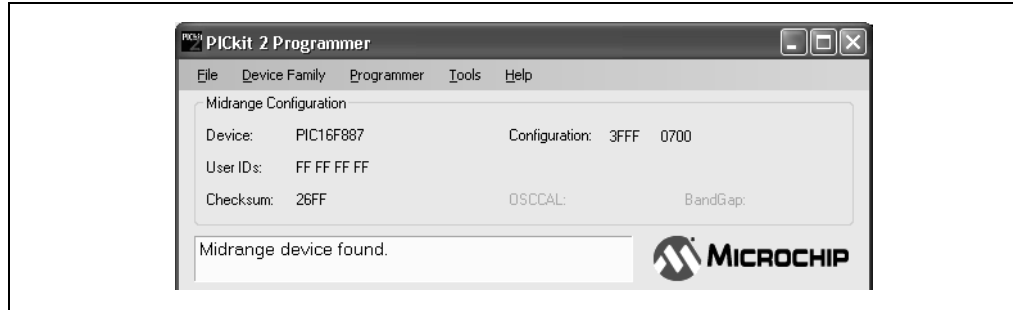

If the Baseline (12-bit core) Flash device family is selected, the user must select the specific device from the device drop down box as shown in Figure 2-4.

CAUTION

Ensure that the correct Baseline Flash device has been selected. These devices do not contain a device ID to confirm device selection. Choosing the wrong Baseline Flash device may cause an erasing of the OSCCAL value stored in the last memory location.

FIGURE 2-4: SELECT BASELINE FLASH DEVICE

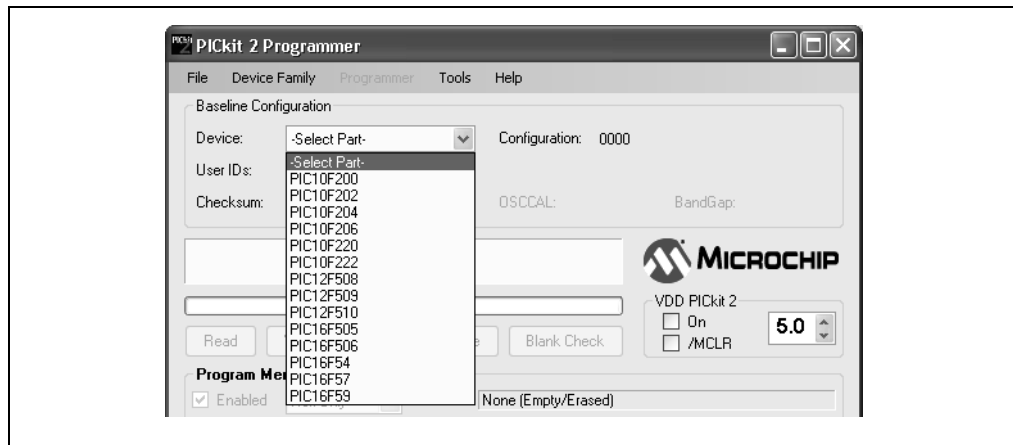

2.3.3 Target Power

The PICkit™ 2 Microcontroller Programmer can supply power to the target. To enable power to the target device, check the VDD PICkit™ 2 “On” check box as shown in Figure 2-5.

The voltage supplied to the target may be adjusted before or after enabling power by adjusting the voltage box.

Note: When starting the PICkit™ 2 Microcontroller Program, target power defaults to off.

Note: If a target power supply is not detected, the PICkit™ 2 Microcontroller Programmer will always supply power to the target during programming, regardless of the VDD PICkit™ 2 “On” check box state.

PICKit™ 2 MCU Programmer User's Guide

CAUTION

The USB port current limit is set to 100 mA. If the target plus PICKit™ 2 Microcontroller Programmer exceed this current limit, the USB port will turn off. The target may be powered externally if more power is required.

FIGURE 2-5: ENABLE TARGET POWER

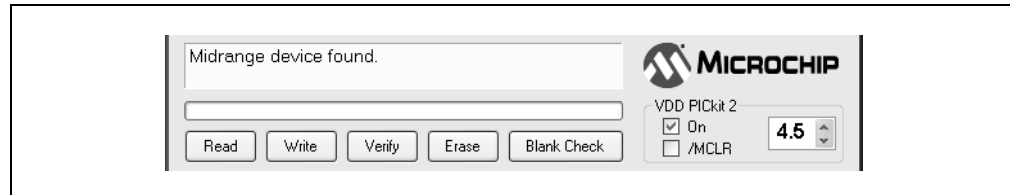

If a short or heavy current load is detected on the PICKit™ 2 Microcontroller Programmer supplied VDD, then the user will receive an error as in Figure 2-6 and VDD will be automatically disabled.

To avoid heavy current load errors, it is recommended to keep the target current consumption below 25 mA. Large VDD capacitances should also be avoided as they slow down the VDD risetime. The allowed VDD rise time is 500 μ s or less.

FIGURE 2-6: VDD ERROR

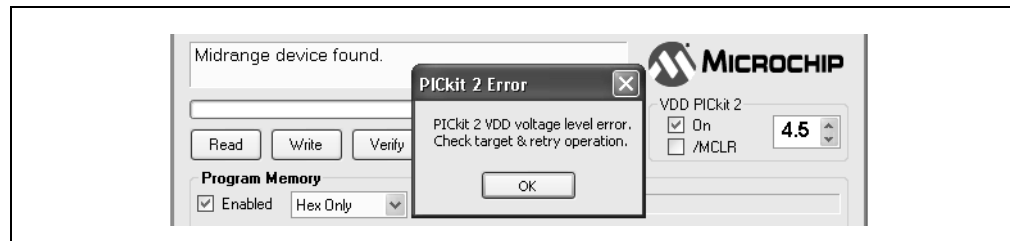

The target device may also be powered externally. By default, the PICKit™ 2 Programmer will automatically detect an externally powered board. The Device VDD will be updated to "VDD Target", the check box text will change to "Check", and the detected VDD voltage is displayed in the grayed out voltage box as in Figure 2-7.

Clicking the check box will update the detected VDD voltage displayed in the voltage box. If no VDD voltage is detected when the check box is clicked, then PICKit™ 2 Programmer will return to supplying VDD power to the target device.

Note: The maximum external VDD that may be used with the PICKit™ 2 Programmer is 5.0 Volts. The minimum external VDD that may be used with the PICKit™ 2 Programmer is 2.5 Volts.

FIGURE 2-7: EXTERNALLY POWERED TARGET

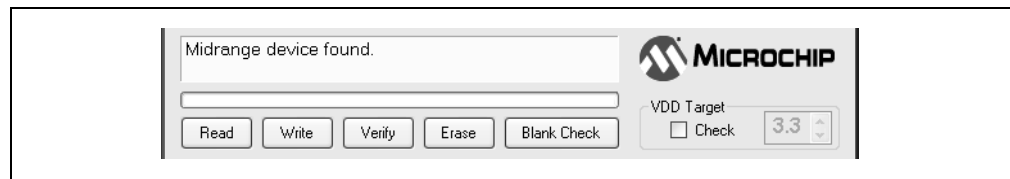

2.3.4 Import HEX File

To import a compiled program (hex file), select *File > Import HEX* as shown in Figure 2-8. Browse for the hex file and click **Open**. The code is displayed in the Program Memory and EE Data Memory windows. The name of the hex file is displayed in the Source block.

The PICkit™ 2 Microcontroller Programmer will warn the user if the hex file does not contain any Configuration Words. The user can be sure these are included in the hex file by selecting *File > Export* and saving the hex file in MPLAB® IDE.

The user will also be warned that the hex file is larger than the selected device if the hex file contains memory locations that do not exist in the current device. Any data for non-existent locations will not be imported.

FIGURE 2-8: IMPORT HEX FILE

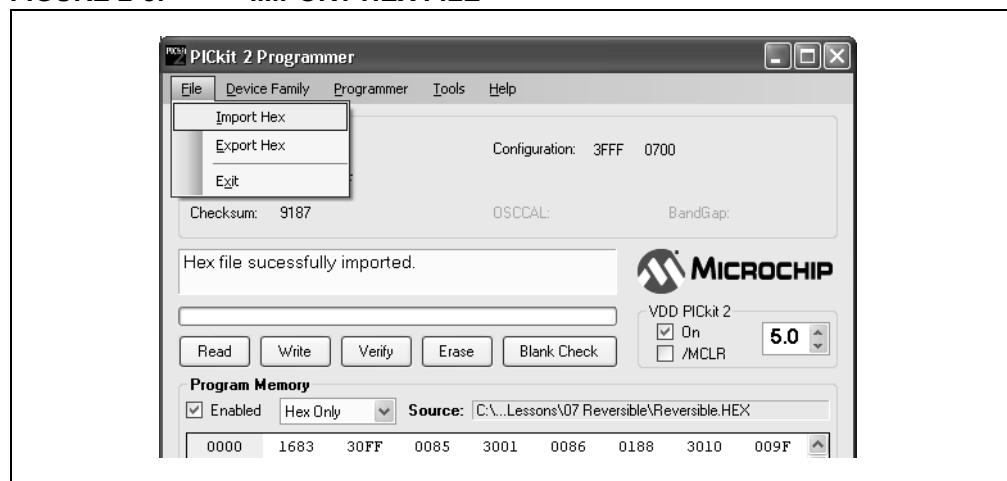

2.3.5 Write

After a device family has been selected and a hex file has been imported, the target PIC® MCU can be programmed by clicking on the **Write** button. The PIC® MCU will be erased and programmed with the hex code previously imported. The status of the Write operation is displayed in the status bar located under the Device Configuration window.

Note: The device will be erased prior to programming. The PICkit™ 2 Microcontroller Programmer uses the bulk erase method that requires a minimum VDD. The user will be warned if VDD is below the minimum for the connected device.

If the write is successful, the status bar turns green and displays “Programming Successful”, as shown in Figure 2-9.

FIGURE 2-9: WRITE SUCCESSFUL STATUS

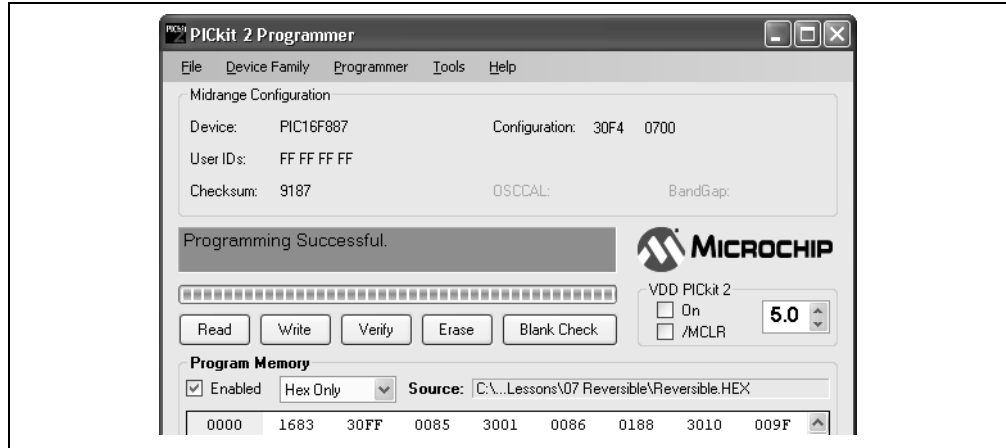

If the write fails, the status bar turns red and displays “Programming Failed”, as shown in Figure 2-10. This error indicates that the data was corrupted during the programming sequence. If this error is displayed, try writing the program to the device again. If the error continues, see **Chapter 5. “Troubleshooting”** for assistance.

FIGURE 2-10: WRITE ERROR STATUS

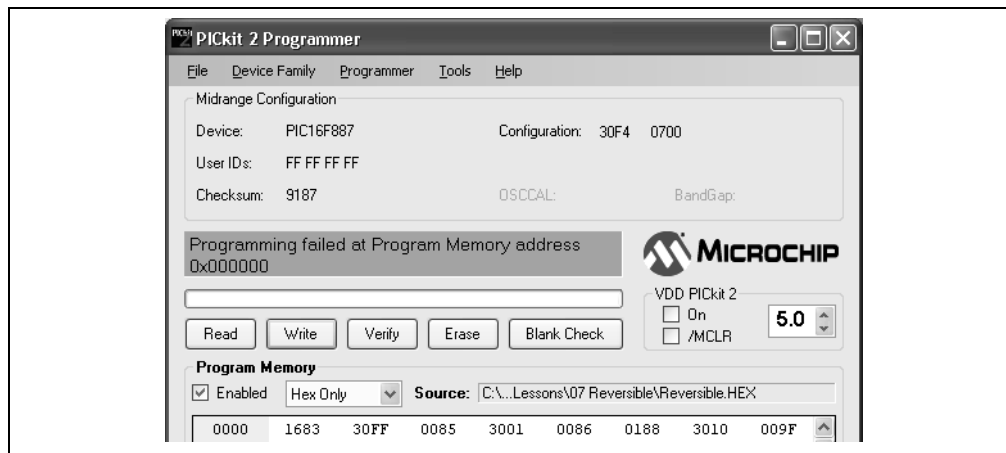

If a device has EEPROM data memory, the “Enabled” checkbox next to Program Memory and EEPROM Data memory will become available.

The checkboxes may be used to select which memory regions programming operations will affect. Refer to Table 2-1 for a description of how programming operations are affected by the checkboxes. **Erase** and **Blank Check** always operate on all memory regions.

During a **Write**, regions that are unaffected will remain unchanged in the device.

For example, if Program Memory is unchecked, while EEPROM Data is checked then a Write operation will only write EEPROM Data, while Program Memory, User IDs, and Configuration Words in the device will remain unchanged. Erase and Blank Check will still operate on all memory regions.

If Program Memory is checked, while EEPROM Data is unchecked then a Write operation will program Program Memory, User IDs, and Configuration Words, while EEPROM Data in the device will remain unchanged.

Note that due to programming constraints in some devices the PICKit™ 2 Microcontroller Programmer Application will read and re-write EEPROM data memory during a write to preserve it. Erase and Blank Check will still operate on all memory regions.

It is not allowed to have both memory regions unchecked.

TABLE 2-1: MEMORY REGION SELECTION

Program Memory Enabled	EEPROM Data Enabled	Write/Read/Verify	Erase/Blank Check
Checked	Checked	All Memory Regions	All Memory Regions
Checked	—	Program Memory User IDS Configuration	All Memory Regions
—	Checked	EEPROM only	All Memory Regions
—	—	<i>Not Allowed</i>	

2.3.6 Automatic File Reload

Prior to each write, the imported hex file time stamp is compared to the version on the disk. If the version on the disk is newer, it is reloaded. This occurs only when a hex file has been read from the disk.

This feature ensures that the latest version built by MPLAB® IDE will be written to the device.

2.3.7 Verify

The Verify function verifies the device program to the imported hex file. It compares all areas of memory including program memory, data EEPROM memory, ID and Configuration bits.

To verify the code, import the hex file and click the **Verify** button. If the code is the same, the status bar turns green and displays “Device Verified”. If a discrepancy is found, the status bar turns red and displays where the error is located: “Error in Program Memory, Data EEPROM Memory, or Configuration Bits”.

Table 2-1 illustrates how Verify is affected by the memory region checkboxes.

2.3.8 Read

To view the code written to the PIC® MCU, click the **Read** button. The code is displayed in the Program and Data EEPROM Memory windows for your review. If all zeros are displayed, it is possible that the device is code-protected.

Table 2-1 illustrates how Read is affected by the memory region checkboxes.

2.3.9 Code-Protect Device

The Code and Data Protect functions enable the read protection features of the PIC® MCU. To protect the program memory code, complete the following steps:

1. Import hex file.
2. Select Tools > Enable Code Protect as shown in Figure 2-11.
3. Click **Write**.

Devices that have EEPROM Data Memory may protect it by selecting Tools > Enable Data Protect.

FIGURE 2-11: ENABLE CODE-PROTECT

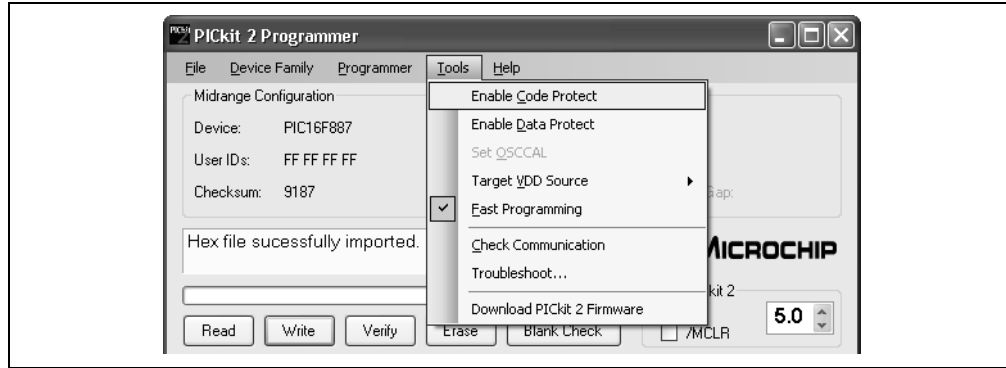

Note: If the device is read after it has been protected, the protected memory regions will display all zeros.

2.3.10 Erase

The Erase function erases the program memory, data EEPROM memory, ID and Configuration bits, regardless of the state of the Program Memory and EEPROM Data “Enabled” checkboxes. However, this function is not normally needed since the Write function performs an erase operation prior to programming the PIC® MCU.

To erase the device, click the **Erase** button.

Note: The PICKit™ 2 Microcontroller Programmer uses the bulk erase method that requires a minimum VDD. The user will be warned if VDD is below the minimum for the connected device.

2.3.11 Blank Check

The Blank Check function will read the entire device to determine if Program Memory, EEPROM Data memory, User IDs, and Configuration bits are erased. All memory regions will be examined, regardless of the state of the Program Memory and EEPROM Data “Enabled” checkboxes.

2.3.12 Auto Import Hex + Write Device Button

This feature allows PICKit™ 2 Programmer to automatically import a hex file and write it to a connected device when the hex file is updated, for example on a new firmware build.

To use this feature, click on the **Auto Import Hex + Write Device** button shown in Figure 2-12. This will bring up an Import Hex file dialog defaulting to the first hex file in the file history under the File menu. After selecting a file, it will be written to the device. The PICKit™ 2 Microcontroller Programmer will now monitor the selected hex file for updates. When the file has been updated (has a newer time stamp), the PICKit™ 2 Microcontroller Programmer will automatically re-import the hex file and write to the target device.

While this feature is enabled, other programming operations are disabled. The **Auto Import Hex + Write Device** button will remain depressed while this feature is active as shown in Figure 2-13. To stop using this feature, click the **Auto Import Hex + Write Device** button again.

If an error is encountered during hex file importing or device programming, the PICKit™ 2 Microcontroller Programmer will automatically exit this feature mode.

FIGURE 2-12: AUTO IMPORT HEX + WRITE DEVICE BUTTON



FIGURE 2-13: AUTO IMPORT + WRITE FEATURE ACTIVE



2.3.13 Read Device + Export Hex File Button

When clicked, this button will read the target device and open an **Export Hex File** dialog.

PICKit™ 2 MCU Programmer User's Guide

NOTES:



Chapter 3. PICKit™ 2 Programmer and ICSP™

3.1 INTRODUCTION

The PICKit™ 2 Microcontroller Programmer can program PIC® microcontrollers that are installed in an application circuit using In-Circuit Serial Programming™ (ICSP™). In-Circuit Serial Programming (ICSP) requires five signals:

- VPP – Programming Voltage; when applied, the device goes into Programming mode.
- ICSPCLK or PGC – Programming Clock; a unidirectional synchronous serial clock line from the programmer to the target.
- ICSPDAT or PGD – Programming Data; a bidirectional synchronous serial data line.
- VDD – Power Supply positive voltage.
- VSS – Power Supply ground reference.

However, the application circuit must be designed to allow all the programming signals to be connected to the PIC microcontroller device without distorting the programming signals. Figure 3-1 shows a typical circuit as a starting point when designing an application circuit for ICSP. For successful ICSP programming, the precautions in the following sections need to be followed.

Note: For details on how a specific device is programmed, refer to the device programming specification available from the Microchip web site at www.microchip.com.

FIGURE 3-1: TYPICAL ICSP™ APPLICATION CIRCUIT

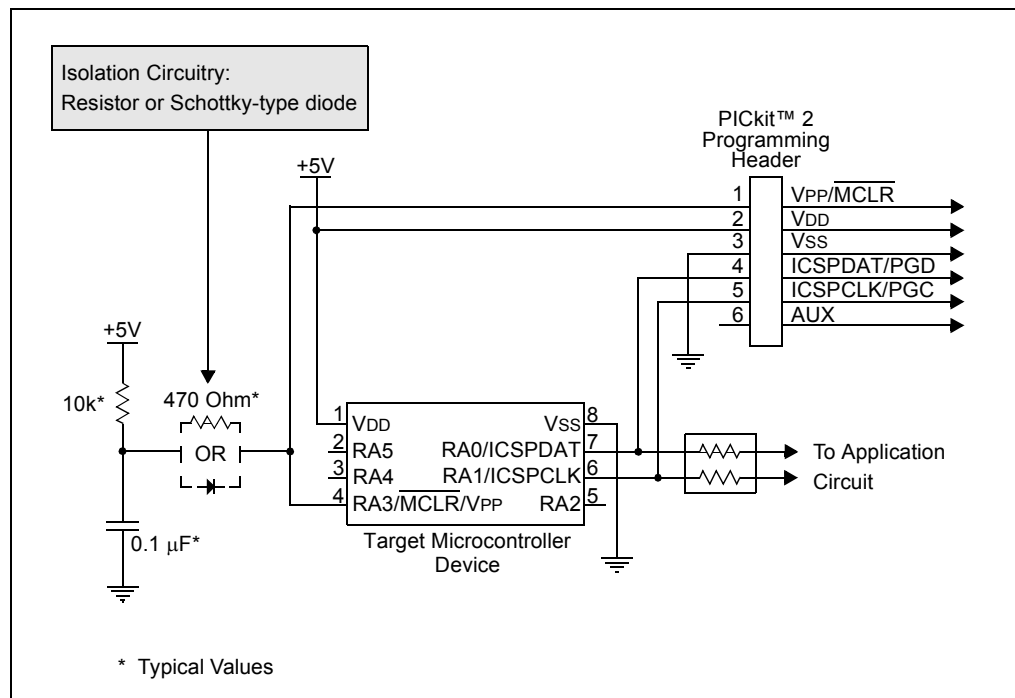

3.2 ISOLATE V_{PP} /MCLR/PORT PIN

When V_{PP} voltage is applied, the application circuit needs to take into consideration that the typical V_{PP} voltage is +12V. This may be an issue in the following situations:

3.2.1 If the V_{PP} pin is used as a MCLR pin.

The application circuit typically is connected to a pull up resistor/capacitor circuit, as recommended in the device data sheet. Care must be taken so that the V_{PP} voltage slew rate is not slowed down and exceeds the rise time in the programming specification (typically 1 μ s).

If a supervisory circuit or a push button is interfaced to the MCLR pin, it is recommended that they be isolated from the V_{PP} voltage by using a Schottky-type diode or limiting resistor as shown in Figure 3-1. For more information about using supervisory circuits with ICSP, see Application Note AN820 "System Supervisors in ICSP™ Architectures" (DS00820).

3.2.2 If the V_{PP} pin is used as an I/O port pin.

The application circuit that connects to the I/O pin may not be able to handle the +12V voltage. It is recommended to use a Schottky-type diode or limiting resistor as shown in Figure 3-1 to isolate the circuitry.

3.3 ISOLATE ICSPCLK OR PGC AND ICSPDAT OR PGD PINS

The ICSPCLK or PGC and ICSPDAT or PGD pins need to be isolated from the application circuit to prevent the programming signals from being affected by the application circuitry. ICSPCLK or PGC is a unidirectional synchronous serial programming clock line from the programmer to the target. ICSPDAT or PGD is a bidirectional synchronous serial programming data line.

If the design permits, dedicate these pins for ICSP. However, if the application circuit requires that these pins be used in the application circuit, design the circuitry in a manner that does not alter the signal level and slew rates. Isolation circuitry will vary according to the application. Figure 3-1 shows one possibility by using series resistors to isolate the ICSP signals from the application circuit.

3.4 VDD

During ICSP programming, the PIC® MCU needs to be powered in accordance with the device specification. Typically, the PIC® MCU supply voltage is connected to the application circuit supply voltage. The application circuit can be powered by the PICkit™ 2 Microcontroller Programmer or externally. There are a few precautions that need to be observed.

3.4.1 The application circuit is powered by the PICkit™ 2 Microcontroller Programmer.

The PICkit™ 2 Microcontroller Programmer supply voltage may set between the maximum and minimum voltages allowed by the device programming specification, unless the minimum is below +2.5V. Be sure to set the voltage box to the appropriate voltage before programming the device or turning on VDD.

CAUTION

The USB port current limit is set to 100 mA. If the target plus PICkit™ 2 Microcontroller Programmer exceeds this current limit, the USB port will turn off. The target may be powered externally if more power is required.

Note: Current draw should be limited to 25 mA when using PICkit™ 2 Microcontroller Programmer to power the application circuit. Ensure that the application circuit does not slow the VDD rise time to longer than 500 μ s.

3.4.2 The application circuit is powered externally.

The PICkit™ 2 Microcontroller Programmer may be used with application circuits powered externally between +5.0V and +2.5V.

3.4.3 Bulk Erase is used.

Some PIC® MCU devices use a bulk erase function to erase program memory, data EEPROM memory, ID locations, and Configuration bits. Typically, the bulk erase function requires a supply voltage (VDD) of 4.5 to 5.5 Volts (refer to the device programming specification for device specific requirements).

This voltage range can be a problem if the application circuit is designed to operate at a different supply voltage range. In order to bulk erase the PIC® MCU, the application circuit needs to take into consideration the bulk erase voltage requirement while protecting any voltage sensitive circuitry.

PICKit™ 2 MCU Programmer User's Guide

3.5 Vss

The power supply ground reference, Vss, must be at the same potential as the application circuit.

3.6 OTHER CONSIDERATIONS

Minimize the distance the ICSP signals must travel by placing the ICSP connector as close to the application circuit PIC® MCU as possible. Minimize any cable length between the PICKit™ 2 Microcontroller Programmer and application circuit PIC® MCU. The goal is to keep the ICSP signals within the level and slew rate specifications for successful programming.



Chapter 4. PICKit™ 2 Debug Express

4.1 INTRODUCTION

The PICKit™ 2 Microcontroller Programmer allows in-circuit debugging on selected PIC® Microcontroller Units (MCUs). In-circuit debugging allows the designer to run, examine and modify the program while the PIC® MCU is embedded in the hardware. This greatly assists the designer in debugging the firmware and hardware together.

The Debug Express software interacts with the MPLAB® IDE software to run, stop and single-step through programs. One breakpoint can be set and the processor can be reset. Once the processor is stopped, the register's contents can be examined and modified.

Note: Debug Express requires MPLAB® IDE 7.50 version, or later.

Note: Debug Express requires 4.7k Ohm pull down resistors on ICSPCLK and ICSPDAT. Newer PICKit™ 2 Microcontroller Programmers that have a Red button have the pull downs internally. Older PICKit™ 2 Microcontroller Programmers that have a Black button require that the pull downs be added on the target board.

4.1.1 Supported Devices

For a list of current devices supported by PICKit™ 2 Debug Express, see the "Readme for PICKit 2.htm" file in the Readmes subdirectory of the MPLAB® IDE installation directory.

4.1.2 Resources Used by PICKit™ 2 Debug Express

Due to the built-in in-circuit debugging capability of ICD devices and the ICSP function offered by the debugger, the PICKit™ 2 Debug Express uses some on-chip resources when debugging.

General Resources for Mid-Range Devices

- $\overline{\text{MCLR}}$ pin reserved for debugging; this pin cannot be used as digital I/O while debugging.
- $\overline{\text{MCLR}}/\text{VPP}$ shared for programming.
- The ICSPDAT and ICSPCLK port pins are reserved for programming and in-circuit debugging. Therefore, other functions multiplexed on these pins will not be available during debug.
- One stack level not available.

Program and Data Memory Resources

The PICKit™ 2 Debug Express uses program memory and file register locations in the target device during debugging. These locations are not available for use by user code. In the MPLAB IDE, registers marked with an "R" in register displays represent reserved registers.

PICKit™ 2 MCU Programmer User's Guide

For device specific reserved locations, see MPLAB® IDE help for the MPLAB® ICD 2. In the MPLAB® IDE, select menu *Help > Topics...*. In the Help Topics dialog under “Debuggers”, select “MPLAB® ICD 2” and click **OK**. In the MPLAB® ICD 2 Help dialog, select “Operation” under the “Contents” tab. Select “MPLAB® ICD 2 Overview” then “Resources Used By MPLAB® ICD 2”. A list of device families will be presented. Select the device family of interest for more information on reserved device resources.

The following documentation may also be referenced:

- MPLAB® ICD 2 In-Circuit Debugger User's Guide (DS51331)

4.2 PICKit™ 2 DEBUG EXPRESS

This section explains how to debug programs using the PICKit™ 2 Debug Express. It is intended for those new to debugging programs, but familiar with the MPLAB® IDE software.

For more information on how to use the MPLAB® IDE software, reference the following documentation:

- MPLAB® IDE User's Guide (DS51519)
- MPLAB® IDE Quick Start Guide (DS51281)
- MPLAB® IDE On-line Help

4.2.1 Selecting the Device and Development Mode

From the MPLAB® IDE menu bar, select the PIC® MCU device for this tutorial:

1. Select *Configure > Select Device*.

FIGURE 4-1: MPLAB® IDE MENU BAR



2. Click on the Device drop-down list and select the PIC16F887 device. No other changes need to be made in this dialog box.
3. Click **OK**.

FIGURE 4-2: SELECT DEVICE

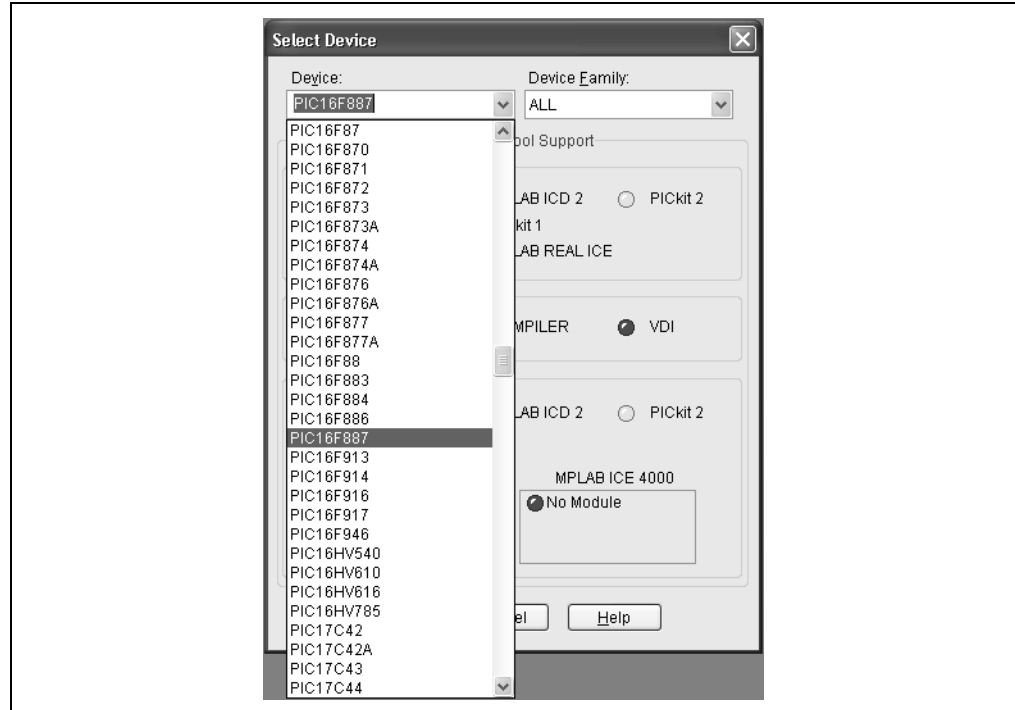

4.2.2 PICkit™ 2 Microcontroller Programmer Debug Tool

Select the PICkit™ 2 Microcontroller Programmer as the debug tool:

- Select *Debugger > Select Tool > PICkit 2*.
The Output window displays communication status between the PICkit™ 2 Microcontroller Programmer and Target Board, as shown in Figure 4-4.

FIGURE 4-3: PICkit™ 2 DEBUG TOOL

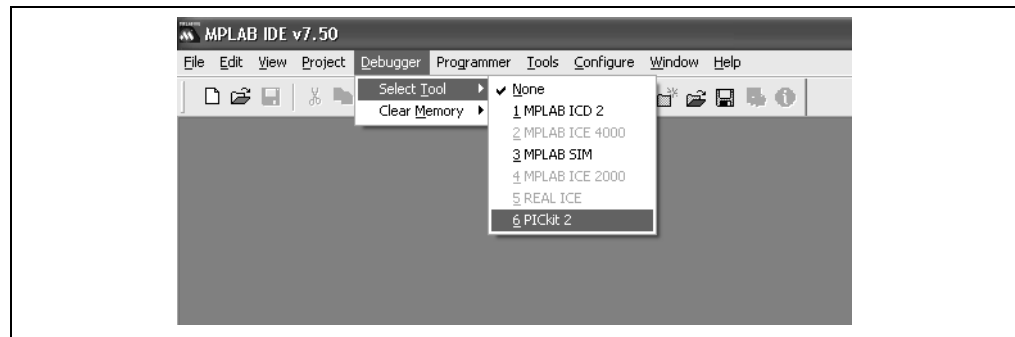

PICkit™ 2 MCU Programmer User's Guide

FIGURE 4-4: OUTPUT WINDOW

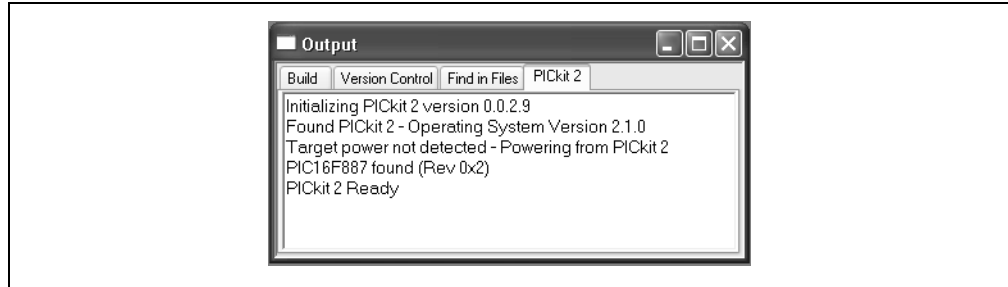

4. Select *Debugger > Settings* to setup the PICkit™ 2 operation.
5. Click the “Connect on Startup” check box to enable the auto-connection feature.
6. Click **Ok**.

FIGURE 4-5: PICkit™ 2 SETTINGS

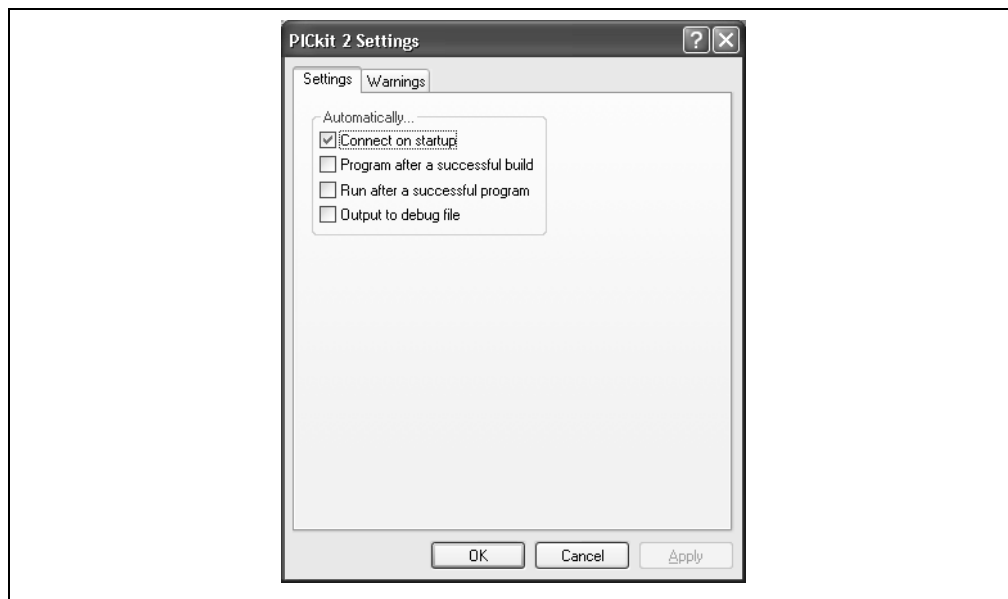

7. Select *Debugger > Connect* to connect to the PICKit™ 2.
The Output window displays communication status between the PICKit™ 2 and Target Board.

FIGURE 4-6: PICKit™ 2 MICROCONTROLLER PROGRAMMER CONNECT

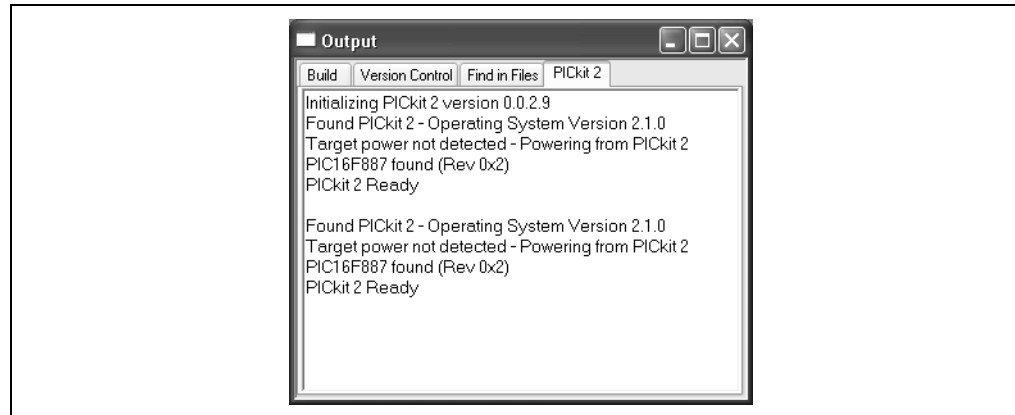

4.2.3 Updating PICKit™ 2 Firmware (Operating System)

Depending on the version of the MPLAB® IDE software or the selected device, a message may appear indicating that the firmware needs to be updated. MPLAB® IDE will automatically install new firmware (see Figure 4-7).

FIGURE 4-7: UPDATING PICKit™ 2 FIRMWARE DIALOG

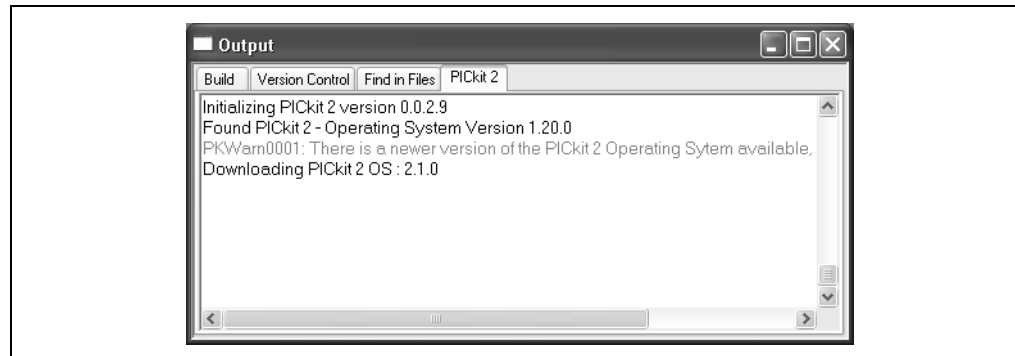

4.2.4 Running the Project Wizard

For this project, the MPASM™ Assembler tool will be used:

1. Select *Project > Project Wizard* to setup the first project. The Project Wizard Welcome menu will display.
2. Click **Next** to continue to Step One.

FIGURE 4-8: PROJECT WIZARD

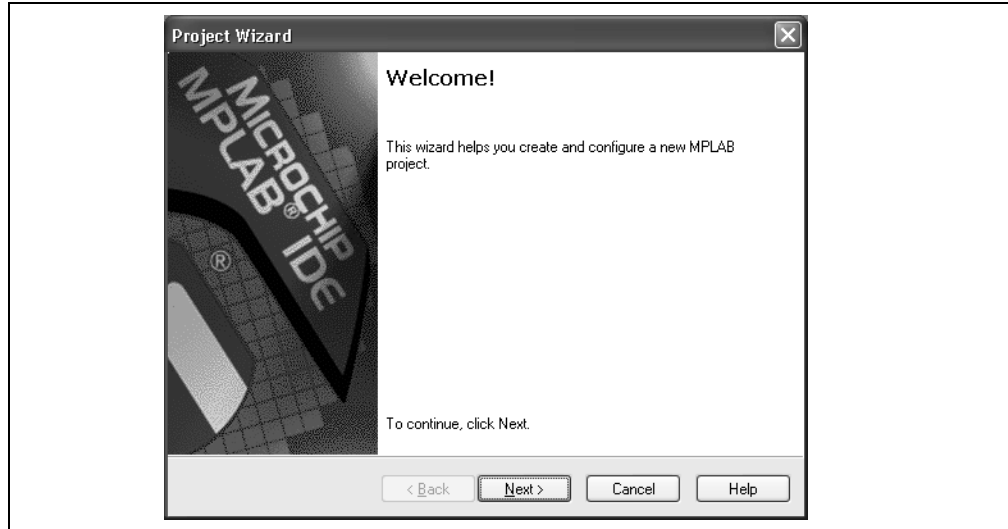

3. Select the **PIC16F887** device from the Device drop-down box.
4. Click **Next** to continue to Step Two.

FIGURE 4-9: STEP ONE



5. Select "Microchip MPASM Toolsuite" from the Active Toolsuite drop-down menu.

Make sure the tools are set to the proper executables by default in the C:\Program Files\Microchip\MPASM Suite folder as follows:

- MPASM assembler should be pointing to mpasmwin.exe
- MPLINK Linker should be pointing to mmlink.exe
- MPLIB Librarian should be pointing to mplib.exe.

6. Click **Next** to continue to Step Three.

FIGURE 4-10: STEP TWO

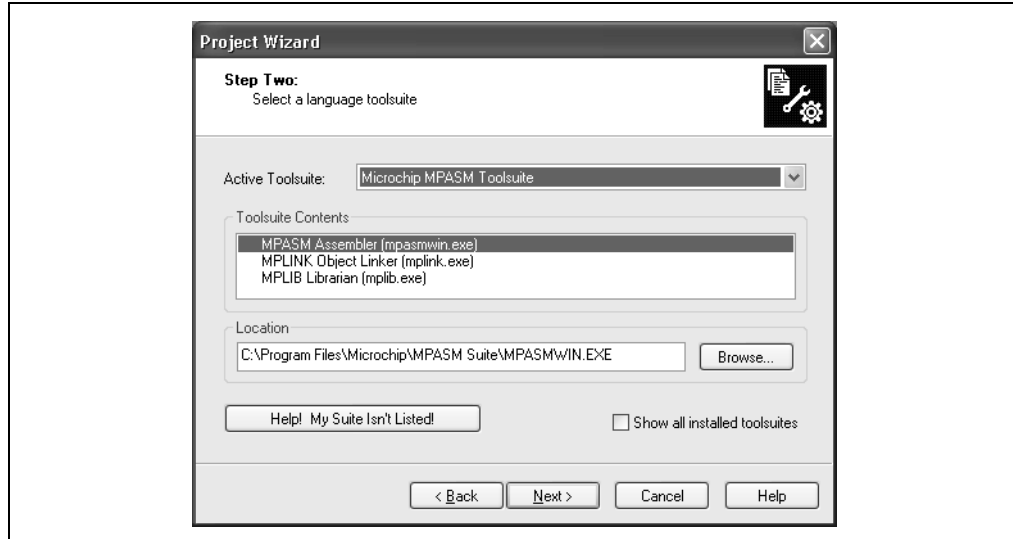

- In Step Three, type in the name and location of the project or click the **Browse** button to locate the project files.
- Click **Next** to continue to Step Four.

FIGURE 4-11: STEP THREE

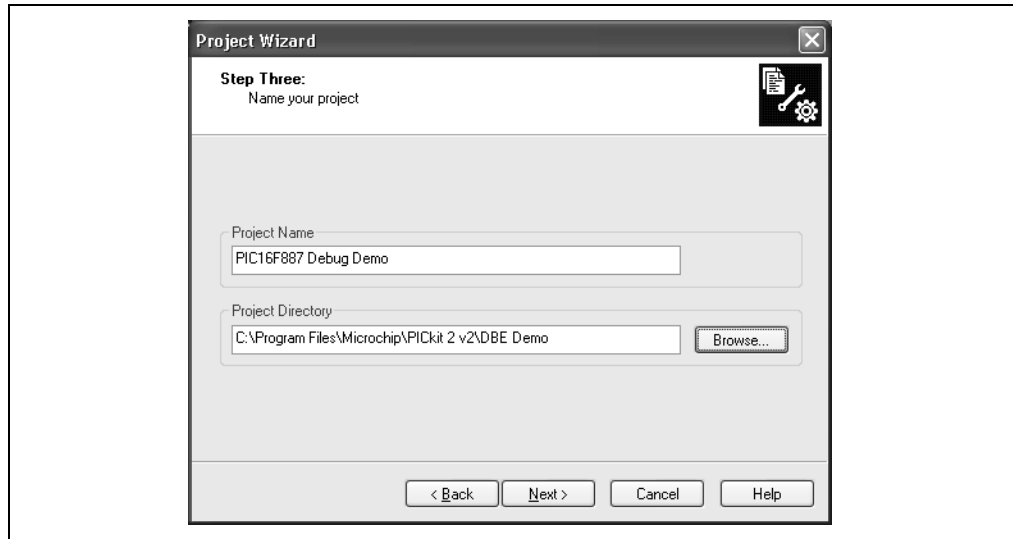

In Step Four, add the project files:

From the left pane window, go to

C:\Program Files\Microchip\PICkit 2 v2\DBE Demo. Select and highlight the 16F887Demo.asm file and click the **Add** button. The file will be placed into the right pane window.

7. Click the check box next to the file to copy the file into the project directory.
8. Click **Next** to continue to the Summary window.

Note: Files can be added later if needed.

FIGURE 4-12: ADD FILES

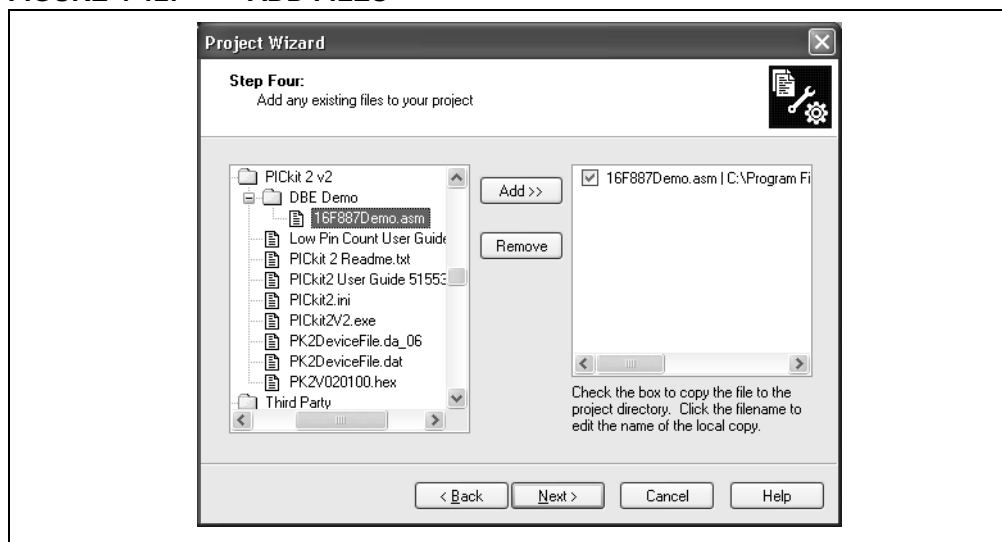

If any errors have been made, click on the **Back** button to return to any of the previous steps in the Project Wizard. Click **Finish**.

FIGURE 4-13: PROJECT SUMMARY

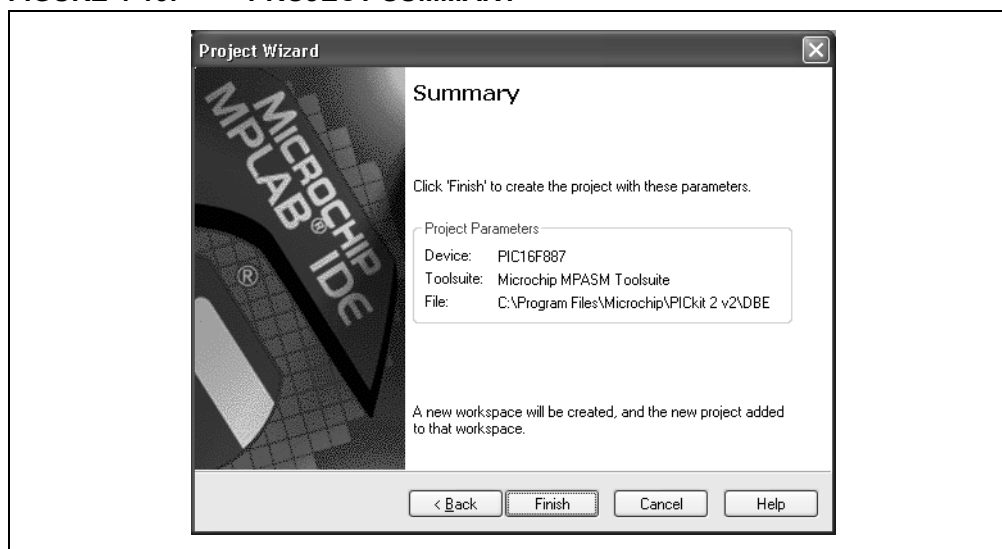

4.2.5 PIC16F887 Debug Demo Project

After completing the project setup and exiting the Project Wizard, the Project Window will display in the MPLAB® IDE desktop window, as shown in Figure 4-14.

FIGURE 4-14: PROJECT WINDOW

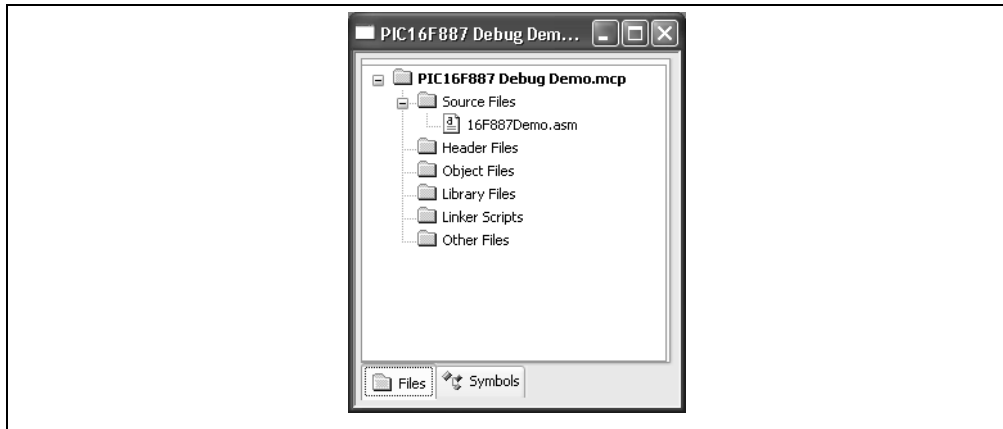

If needed, additional files can be added to the project using the Project Window. Right click on any of the files or folders in the Project Window tree to display a pop-up window with additional options for adding or removing files.

FIGURE 4-15: ADDING AND REMOVING FILES

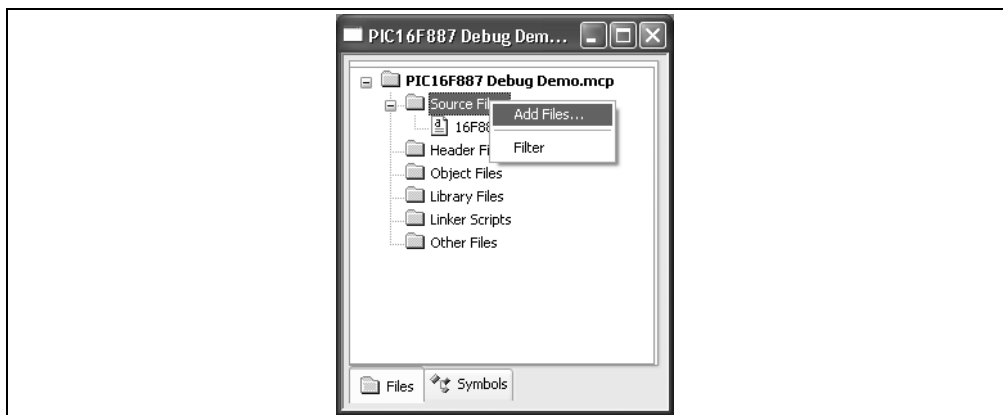

4.2.6 Creating a Hex File

Select *Project > Build All*, or right click on the project name in the Project Window and select "Build All" from the pop-up menu. The MPASM assembler will create a hex file with the same name as the source .asm file.

FIGURE 4-16: BUILD PROJECT

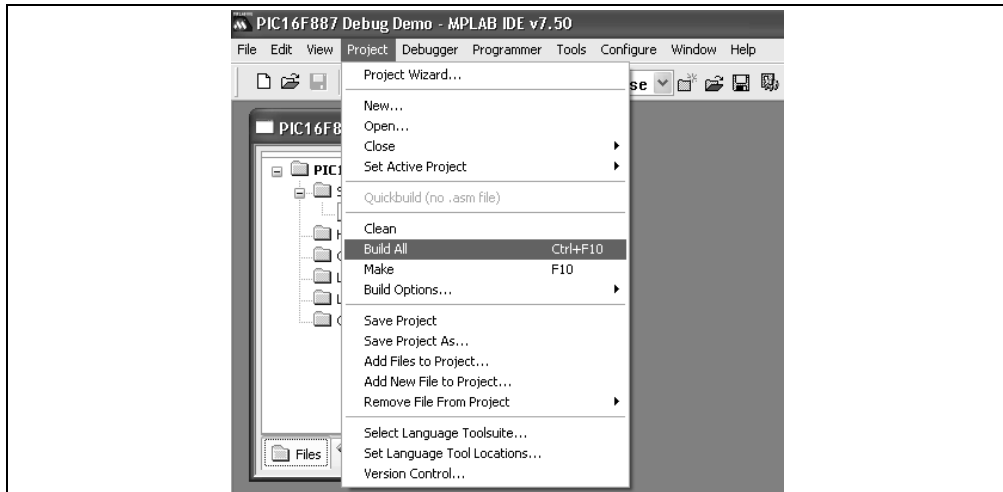
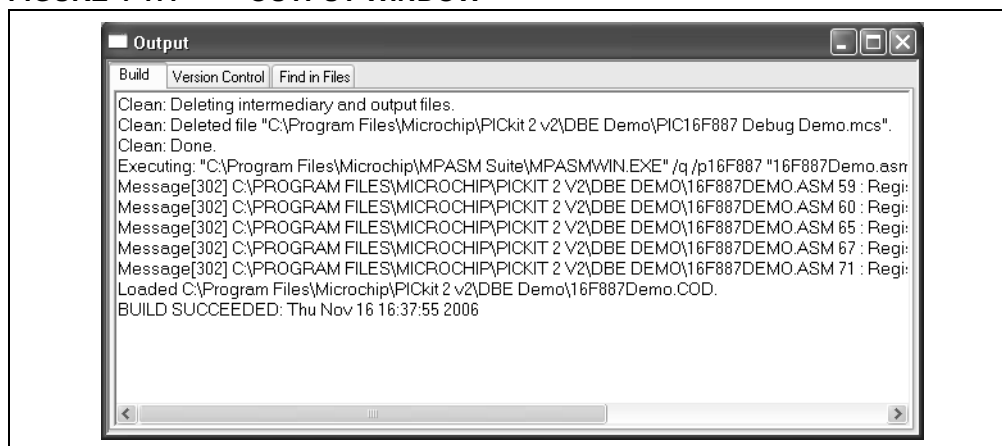

FIGURE 4-17: OUTPUT WINDOW



4.2.7 Setting Debug Options

Before debugging can begin, the device Configuration bits need to be selected.

4.2.7.1 CONFIGURATION BITS

The Configuration bits that are to be programmed into the device are set from within the program. These bits can be verified using the Configuration Bits dialog window.

- Select *Configure > Configuration Bits*.
- To change the setting for a category, double click on the text in the "Setting" column and select the appropriate setting for the corresponding category.

The following Configuration bits should be set for this tutorial:

Config1:

- Oscillator – Internal RC No Clock
- Watchdog Timer – Off
- Power-Up Timer – On
- Master Clear Enable – MCLR is external
- Code-Protect – Off
- Data EE Protect – Off
- Brown-Out Detect – BOD and SBOREN Disabled
- Internal-External Switch Over Mode – Disabled
- Monitor Clock Fail-safe – Disabled
- Low-Voltage Program – Disabled

Config 2:

- Self Write Enable – No Protection
- Master Brown-out Reset Sel Bit – Brown-out at 2.1V

FIGURE 4-18: CONFIGURATION BIT SETTINGS

Address	Value	Category	Setting
2007	20E4	Oscillator	Internal RC No Clock
		Watchdog Timer	Off
		Power Up Timer	On
		Master Clear Enable	/MCLR is external
		Code Protect	Off
		Data EE Read Protect	Off
		Brown Out Detect	BOD and SBOREN disabled
		Internal External Switch Over Mode	Disabled
		Monitor Clock Fail-safe	Disabled
		Low Voltage Program	Disabled
2008	3EFF	Self Write Enable	No protection
		Brown Out Reset Sel Bit	Brown out at 2.1V

4.2.8 Loading Program Code for Debugging

- Select *Debugger > Select Tool > PICkit 2* to select the PICkit™ 2 Microcontroller Programmer as the debug tool.
- Select *Debugger > Program* to program the 16F887Demo.asm file into the PIC16F887 on the 44-Pin Demo Board.

FIGURE 4-19:

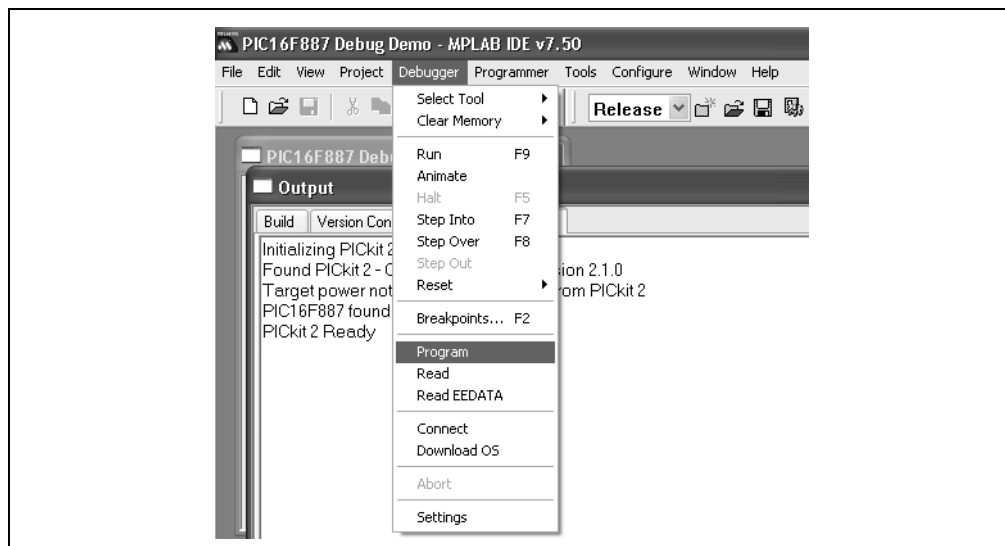

Programming will only take a few seconds. During programming, the **PICkit™ 2** tab of the Output dialog window will display the current phase of operation. When programming is complete, the dialog should look similar to Figure 4-20.

Note: The debug executive code is automatically programmed in the upper program memory of the PIC16F887 (target device) for the PICkit™ 2 debug functions. Debug code must be programmed into the target PIC® MCU to use the in-circuit debugging capabilities of the PICkit™ 2 Programmer.

FIGURE 4-20: OUTPUT WINDOW – PICKIT™ 2 TAB

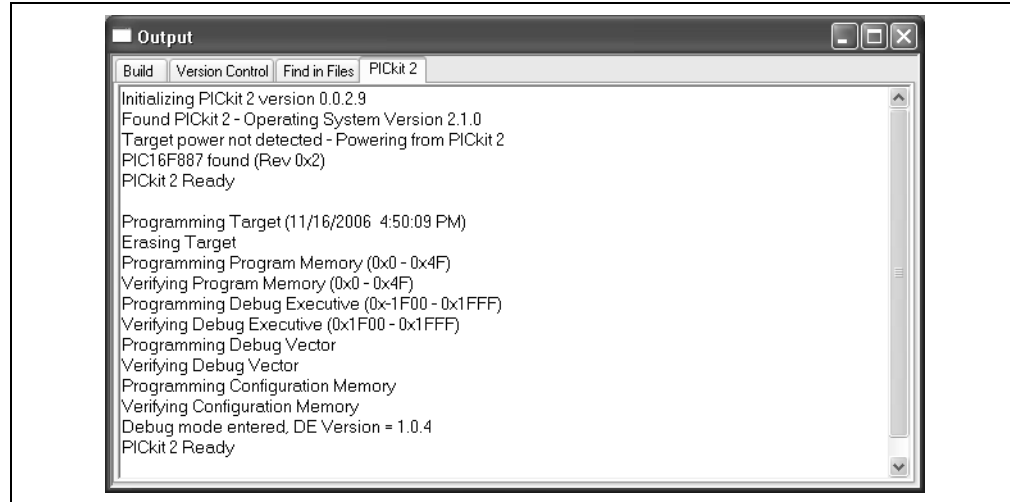

4.2.9 PIC16F887 Debug Demo

The PICkit™ 2 Microcontroller Programmer executes in either Real-Time or Step mode. Real-Time execution occurs when the PIC16F887, on the 44-Pin Demo Board, is in MPLAB® IDE's Run mode. Step mode execution can be accessed after the processor is halted.

The following toolbar buttons can be used for quick access to commonly used debug operations:

Debugger Menu	Toolbar Buttons
Run	
Halt	
Animate	
Step Into	
Step Over	
Step Out	
Reset	

4.2.9.1 REAL-TIME MODE

Open the 16F887Demo.asm file:

1. Double click on the 16F887Demo.asm file from the Project Window or select *File > Open* from the toolbar menu.
2. Select *Debugger > Run*, or click the **Run** button.
3. Turn the potentiometer (RA0), located on the demo board and observe the LEDs.

If the program was working properly, the LEDs would rotate faster or slower depending on which direction the potentiometer is turned. However, a bug has been intentionally placed in the code for debugging demonstration purposes. See the next section **Section 4.2.10 “Debugging the PIC16F887 Debug Demo Code”** for debugging instructions.

4. Select *Debugger > Halt*, or click the **Halt** button to stop the program execution.
5. Select *Debugger > Reset* to reset the program.

4.2.10 Debugging the PIC16F887 Debug Demo Code

Any of the following issues can prevent the PIC16F887 Debug Demo program from working properly:

- The A/D converter value is not being written properly to the Delay routine.
- The A/D converter is not enabled or has not been set to convert.
- A typing error in the source code has caused the program to function improperly.

To explore the first listed possible issue, set a breakpoint at the line of code that writes the value of the A/D result to the high-order Delay byte:

1. Place the cursor on the following line of code in the 16F887Demo.asm file:
`movwf Delay+1`, as shown in Figure 4-21.
 At this breakpoint, the program will stop once the A/D conversion has completed.
2. Right click to display a drop-down menu.
3. Select Set Breakpoint from the drop-down menu.
 The program marks the line with the letter B in a red octagon outline, as shown in Figure 4-21.

FIGURE 4-21: BREAKPOINT

```

C:\A...16F887Demo.asm
70      movlw   0x00      ; A2D Left-Justified, references are
71      movwf   ADCON1
72      banksel ADCON0      ; address Register Page 0
73      movlw   0x40
74      movwf   ADCON0      ; configure A2D for Fosc/8, Channel 0
75      InitRegisters:
76      banksel Display
77      movlw   0x80
78      movwf   Display
79      clrfs   Direction
80      clrfs   LookingFor      ; Looking for a 0 on the button
81      MainLoop:
82      movf   Display,w      ; Copy the display to the LEDs
83      movwf   PORTD
84      nop
85      nop      ; wait total of 5uS for A2D amp to se
86      nop      ; wait 1uS
87      nop      ; wait 1uS
88      nop      ; wait 1uS
89      bsf    ADCON0,GO_DONE ; start conversion
90      btfsz  ADCON0,GO_DONE ; this bit will change to zero when t
91      goto   $-1
92      movf   ADRESH,w      ; Copy the A2D result to the delay lo
93      movwf   Delay+1
94
95      A2DDelayLoop:
96      incfsz Delay,f      ; Waste time.
97      goto   A2DDelayLoop ; The Inner loop takes 3 instructions
98      incfsz Delay+1,f    ; The outer loop takes and additional
99      goto   A2DDelayLoop ; (768+3) * 256 = 197376 instructions
100
101

```

4. Select *Debugger > Run*, or click the **Run** button to run the program in Real-Time mode.
 A breakpoint stops a program's execution when the program executes the line marked as a breakpoint.
5. Mouse over "ADRESH" in the listing file and it will show the value of the file register (see Figure 4-22).

FIGURE 4-22: ADRESH REGISTER VALUE

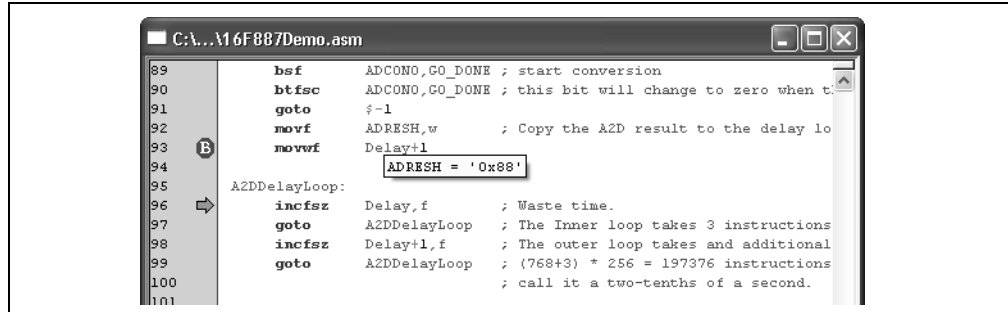

The screenshot shows a window titled "C:\...\M16F887Demo.asm" with assembly code. A mouse cursor is hovering over the instruction "ADRESH = '0x88'" on line 93. The code includes instructions for starting conversion, copying the A2D result to the delay loop, and a delay loop.

```
89      bsf      ADCON0,GO_DONE ; start conversion
90      btfsz   ADCON0,GO_DONE ; this bit will change to zero when t
91      goto    $-1
92      movf    ADRESH,w      ; Copy the A2D result to the delay lo
93      movwf   Delay+1      ADRESH = '0x88'
94
95      A2DDelayLoop:
96      incfsz  Delay,f      ; Waste time.
97      goto    A2DDelayLoop ; The Inner loop takes 3 instructions
98      incfsz  Delay+1,f    ; The outer loop takes and additional
99      goto    A2DDelayLoop ; (768+3) * 256 = 197376 instructions
100
101      ; call it a two-tenths of a second.
```

6. Adjust the POT and continue the program continue by selecting *Debug > Run*. The program will run through the loop and halt.
7. Mouse over “ADRESH” again, the A/D result has not changed. Thus it seems the A/D conversion is not working. The A/D conversion initialization and setup occurs at the beginning of the program.

FIGURE 4-23: PROGRAM HALTED

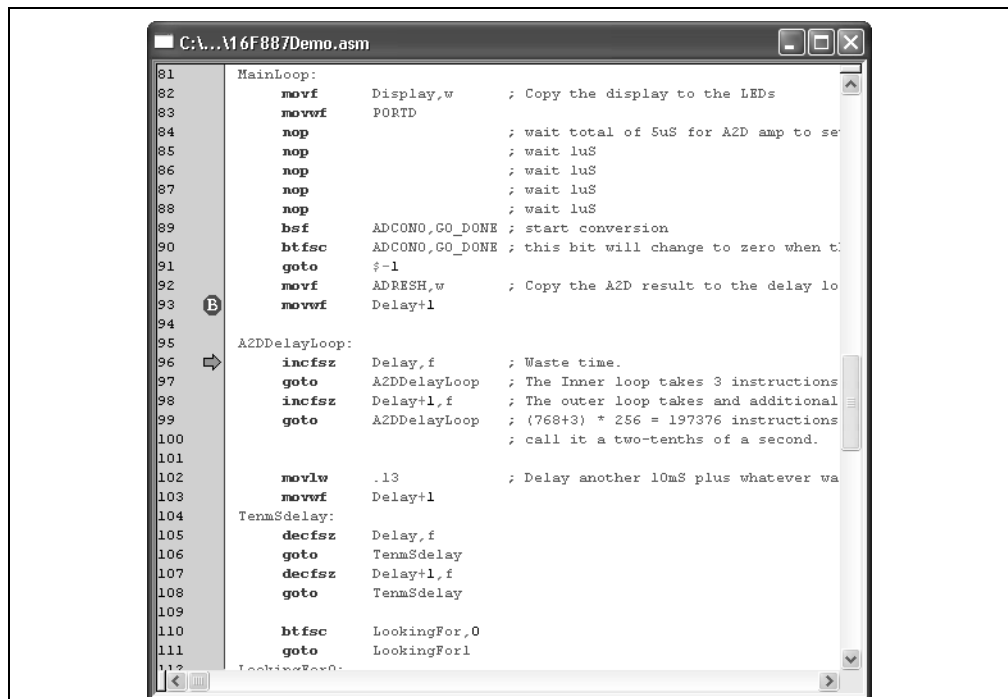

The screenshot shows the same assembly code editor as Figure 4-22, but the program is halted. A green arrow points to the instruction "incfsz Delay,f" on line 96. The code includes instructions for copying the display to the LEDs, waiting for the A2D amp to settle, starting conversion, copying the A2D result to the delay loop, and a delay loop.

```
81      MainLoop:
82      movf    Display,w    ; Copy the display to the LEDs
83      movwf   PORTD
84      nop
85      nop      ; wait total of 5uS for A2D amp to se
86      nop      ; wait 1uS
87      nop      ; wait 1uS
88      nop      ; wait 1uS
89      bsf      ADCON0,GO_DONE ; start conversion
90      btfsz   ADCON0,GO_DONE ; this bit will change to zero when t
91      goto    $-1
92      movf    ADRESH,w    ; Copy the A2D result to the delay lo
93      movwf   Delay+1
94
95      A2DDelayLoop:
96      incfsz  Delay,f      ; Waste time.
97      goto    A2DDelayLoop ; The Inner loop takes 3 instructions
98      incfsz  Delay+1,f    ; The outer loop takes and additional
99      goto    A2DDelayLoop ; (768+3) * 256 = 197376 instructions
100
101      ; call it a two-tenths of a second.
102
103      movlw   .13          ; Delay another 10mS plus whatever wa
104      movwf   Delay+1
105
106      TemmSdelay:
107      decfsz  Delay,f
108      goto    TemmSdelay
109      decfsz  Delay+1,f
110      goto    TemmSdelay
111
112      btfsz   LookingFor,0
113      goto    LookingFor1
```

8. Select *Debugger > Reset* to reset the program. The first instruction should be indicated by a green arrow.
9. Select *View > Watch* to open a new Watch window. This window allows the user to watch the A/D register value change as the program executes. The Watch dialog opens with the **Watch_1** tab selected, as shown in Figure 4-24.

FIGURE 4-24: WATCH WINDOW

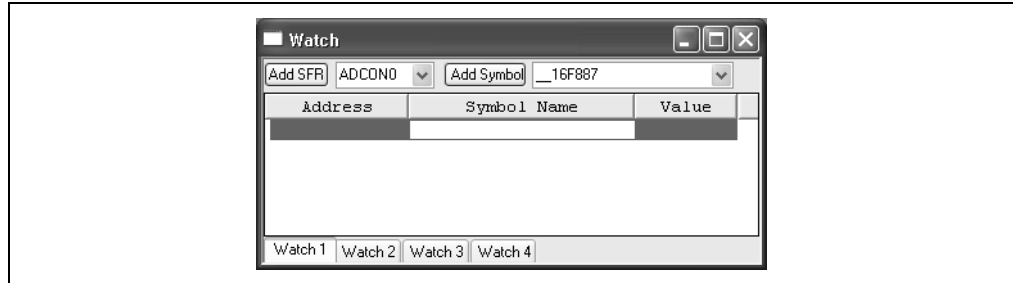

10. Select ADCON0 and click on the **Add SFR** button to add ADCON0 to the Watch window.
11. Repeat Step 10 to add ADCON1 and ADRESH to the Watch window. The selected SFRs should be visible in the Watch window as shown in Figure 4-25.

FIGURE 4-25: ADD SFR

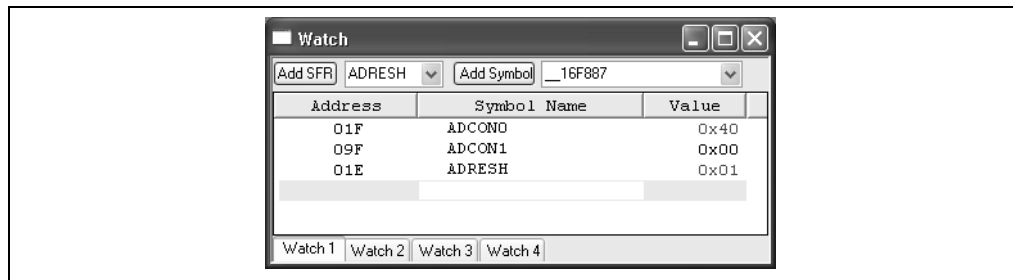

12. Select *Debugger > Run* to run the program in Real-Time mode. This time the program will stop after it executes the breakpoint line of code and the instruction after the breakpoint will be indicated as shown in Figure 4-26.

FIGURE 4-26: PROGRAM HALTED AFTER BREAK

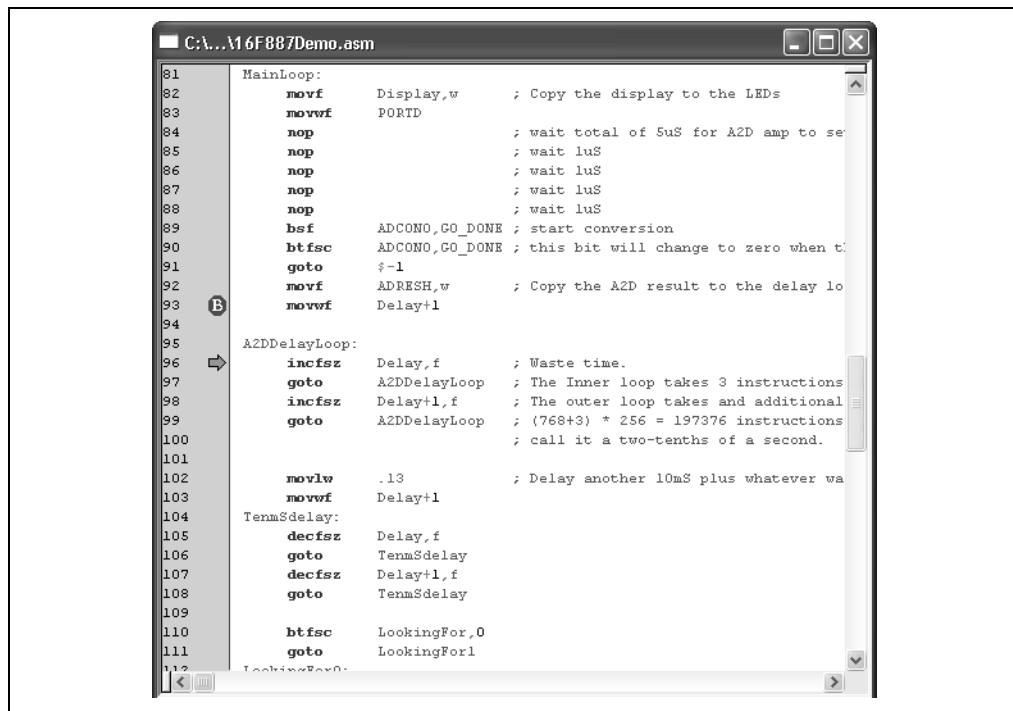

PICkit™ 2 MCU Programmer User's Guide

13. Examine the values of the ADCON0 and ADCON1 registers in the Watch window. The ADCON0 value is '0x40' (b' 01000000'). This corresponds to the hex value designated in the program. However, this is not correct. A review of the "PIC16F882/883/884/886/887 Data Sheet" (DS41291), Analog-to-Digital (A/D) Converter Module section, indicates that the last bit should be a '1' (b' 01000001') to turn on the A/D module. To fix this bug, change:
"movlw 0x40"
to
"movlw 0x41", as shown in Figure 4-27.

FIGURE 4-27: A/D MODULE CODE

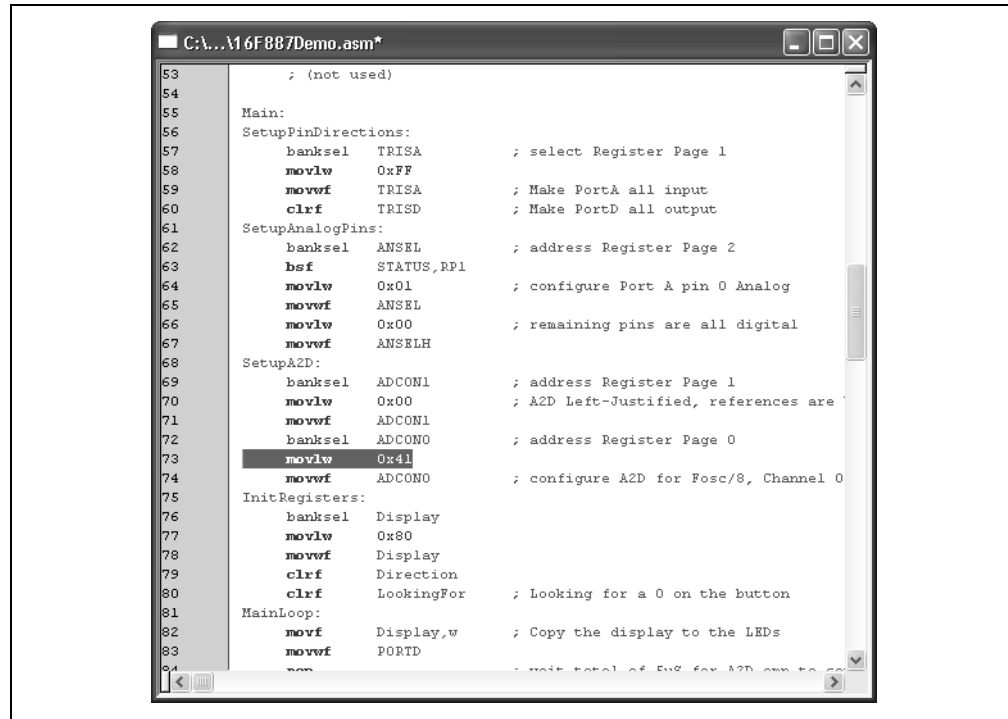

```
53      ; (not used)
54
55  Main:
56  SetupPinDirections:
57      banksel   TRISA           ; select Register Page 1
58      movlw    0xFF
59      movwf    TRISA           ; Make PortA all input
60      clrf     TRISD           ; Make PortD all output
61
62  SetupAnalogPins:
63      banksel   ANSEL          ; address Register Page 2
64      bsf      STATUS,RP1
65      movlw    0x01           ; configure Port A pin 0 Analog
66      movwf    ANSEL
67      movwf    ANSELH
68
69  SetupA2D:
70      banksel   ADCON1         ; address Register Page 1
71      movlw    0x00           ; A2D Left-Justified, references are
72      banksel   ADCON0         ; address Register Page 0
73      movlw    0x41           ;
74      movwf    ADCON0         ; configure A2D for Fosc/8, Channel 0
75
76  InitRegisters:
77      banksel   Display
78      movlw    0x80
79      movwf    Display
80      clrf     Direction
81      clrf     LookingFor     ; Looking for a 0 on the button
82
83  MainLoop:
84      movf     Display,w       ; Copy the display to the LEDs
85      movwf    PORTD
86      ; wait total of 5µS for A2D conv to complete
```

14. Select **File > Save** to save the changes.
15. Select **Project > Build All** to rebuild the project. A message will indicate that the program has been rebuilt. The PICkit™ 2 Programmer must be reprogrammed for the changes to take effect.
16. Select **Debugger > Program** to reprogram the PICkit™ 2 Programmer with the changes. When the PICkit™ 2 Programmer dialog indicates "Programming Succeeded", the program is ready to run again.
17. Right-click on the line of code that previously had the breakpoint and select **Remove > Breakpoint**.
18. Select **Debugger > Run** to run the program in Real-Time mode. Turn the potentiometer (RA0) to change the value displayed on the LEDs.

The source code in this tutorial contained only one bug. However, real code may have more. Using the PICkit™ 2 Programmer and MPLAB® IDE debugging functions, users can successfully find and fix problems in their code.

4.2.11 Programming the Application

When the program is successfully debugged and running, the next step is to program the PIC® MCU for stand-alone operation in the finished design. When doing this, the resources reserved by the ICD are released for use by the application. To program the application, use the following steps:

1. Disable PICkit™ 2 Programmer as a debug tool by selecting *Debugger > Select Tool > None*.
2. Select PICkit™ 2 Programmer as the programmer in *Programmer > Select Tool* menu.
3. Optional: Set up the ID in *Configure > ID Memory*.

FIGURE 4-28: CONFIGURE – ID MEMORY

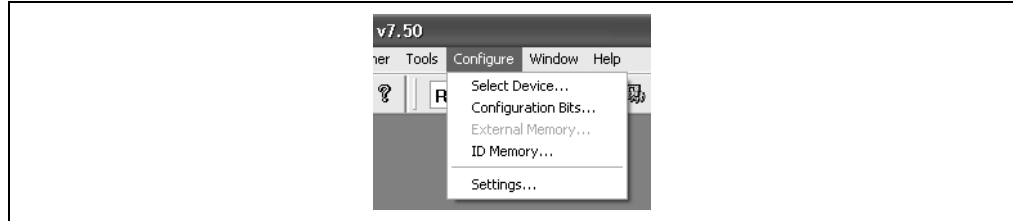
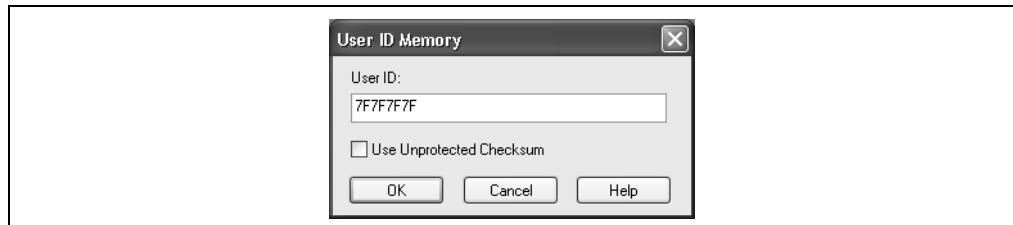

FIGURE 4-29: USER ID MEMORY



4. Set up the parameters for programming on the *Programmer > Settings Program* tab.
5. Select *Programmer > Program*.

Now the PICkit™ 2 Programmer can reset and run the target.

PICKit™ 2 MCU Programmer User's Guide

NOTES:



Chapter 5. Troubleshooting

5.1 INTRODUCTION

This chapter describes questions and answers to common problems associated with using the PICKit™ 2 Microcontroller Programmer and how to resolve them.

5.2 FREQUENTLY ASKED QUESTIONS

Device is not recognized

Question

Why am I receiving a “*No Device Found*” message?

Answer

Verify that the device is supported and that the target MCU is connected to the PICKit™ 2 Microcontroller Programmer in accordance with **Chapter 3. “PICKit™ 2 Programmer and ICSP™”**. Verify that PIC18F_J_, PIC24, and dsPIC33 devices have an appropriate capacitance on the VDDCORE/VCAP pin in accordance with the device data sheet.

Current Limit Exceeded

Question

Why am I receiving the error message “*USB Hub Current Limit Exceeded*” from the Microsoft® Windows® program?

Answer

Check the application circuit is not drawing more than about 25 mA from the PICKit™ 2 Programmer.

Microsoft® Windows® Driver

Question

After plugging the PICKit™ 2 Microcontroller Programmer into the USB port, Windows® 98 SE asks for a driver. Where is the driver?

Answer

PICKit™ 2 Microcontroller Programmer uses the drivers included with Windows®. When Windows® 98 SE prompts for a driver, select “*Search for the best driver for your device.*” Then select the check box next to “*Microsoft Windows Update*” and click **Next**. Windows will automatically install the appropriate driver. Do not use Microchip’s ICD 2 USB driver.

Verify and Read Return all Zeros

Question

When the **Verify** or **Read** buttons are clicked, the Program Memory window comes up with all zeros. What is wrong?

Answer

The device may be code-protected. Ensure code protection has not been selected in the Configuration Word.

PICKit™ 2 MCU Programmer User's Guide

Microsoft® Windows® 95/98/NT

Question

Can I run on Windows® 95/98/NT?

Answer

No. These operating systems either do not support USB or have drivers that are not compatible.

VDD/VPP Errors

Question

Why do I keep getting a “VDD Error” or “VPP Error”?

Answer

This error indicates that the PICKit™ 2 Programmer is not able to drive VDD or VPP to the intended voltage. Check the circuit board for shorts, for large current draw, and verify that the target MCU is connected to the PICKit™ 2 Programmer in accordance with **Chapter 3. “PICKit™ 2 Programmer and ICSP™”**. Make sure that VDD capacitance is not reducing the VDD rise time longer than 500 μ s.

Programming Errors

Question

Why am I able to program some parts but not others?

Answer

If some parts are configured for Low-Voltage Programming, a floating PGM pin can interfere with programming. Use a resistor to pull this pin low when programming.

Some Mid-Range parts, such as the PIC16F72, 73, 74, 76, 77 family and PIC16F737, 747, 767, 777 family require a minimum programming VDD of +4.75V. Depending on the USB voltage, the PICKit™ 2 Microcontroller Programmer may not be able to supply +4.75V on VDD. Program these parts using an external +5.0V power supply.

Some PIC18F parts require significant bypass capacitance on VDD. Try increasing the total bypass capacitance up to 10 μ F.

PIC18F_J_ parts, PIC24, and dsPIC® DSC parts require a 4.7 μ F capacitor on the VDDCORE/VCAP pin in order to function properly. If not using a separate regulator to supply VDDCORE, ensure that the ENVREG pin is tied to VDD.

Debug Express Connection Problems

Question

While using PICKit™ 2 Programmer as a debugger, I frequently get the error “Unable to Enter Debug Mode” when programming the device. What’s wrong?

Answer

During debugging the ICSPCLK and ICSPDAT signal lines must be completely isolated from other circuitry in the application. PICKit™ 2 Microcontroller Programmers with a black push button require that 4.7k Ohm pull-down resistors be added from both ICSPCLK and ICSPDAT to GND. Newer PICKit™ 2 Microcontroller Programmers with a red push button have the pull downs internally.



Chapter 6. Updating the PICKit™ 2 Programmer Operating System

6.1 INTRODUCTION

This chapter describes how to update the PICKit™ 2 Microcontroller Programmer's operating system.

6.2 UPDATING THE PICKit™ 2 MICROCONTROLLER PROGRAMMER

To update the PICKit™ 2 Microcontroller Programmer Operating System, complete the following steps.

Step 1. Download the latest PICKit™ 2 Microcontroller Programmer Operating System from the Microchip web site at www.microchip.com.

Step 2. From the menu, select *Tools > Download PICKit 2 Operating System* as shown in Figure 6-1.

FIGURE 6-1: DOWNLOAD PICKit™ 2 PROGRAMMER OPERATING SYSTEM

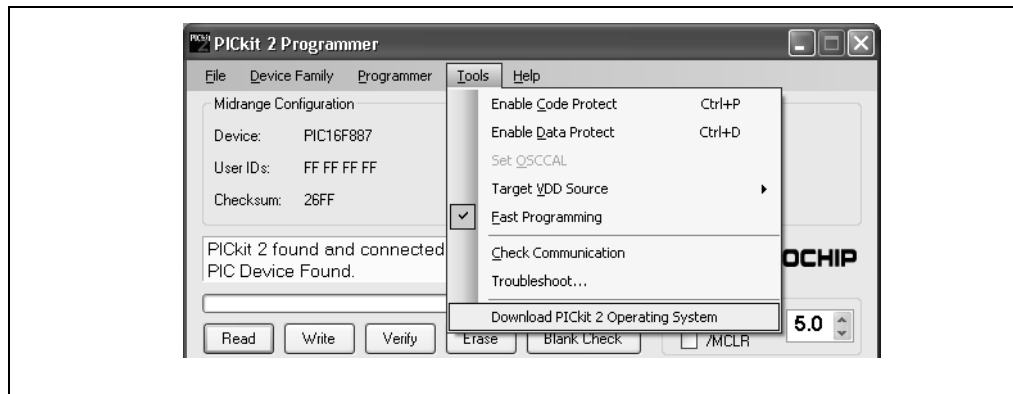

Step 3. Browse to the directory where the latest Operating System code was saved as shown in Figure 6-2.

FIGURE 6-2: OPEN PICKit™ 2 PROGRAMMER OPERATING SYSTEM

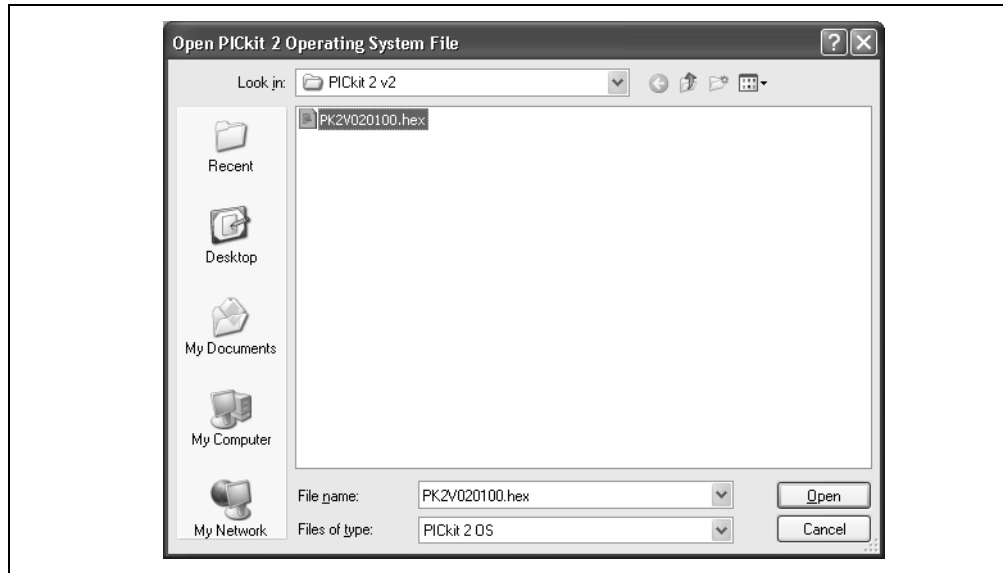

Step 4. Select the PK2* .hex file and click on the **Open** button.

The progress of the OS update will be displayed in the status bar of the programming software and the Busy LED on the PICKit™ 2 Microcontroller Programmer will flash. When the update completes successfully, the status bar will display "Operating System Verified" and the Busy LED will go out. The operating system update is then complete.



Appendix A. Hardware Schematics

A.1 INTRODUCTION

This appendix contains PICKit™ 2 Microcontroller Programmer schematic diagrams.

FIGURE A-1: PICKit™ 2 MICROCONTROLLER PROGRAMMER SCHEMATIC DIAGRAM (PAGE 1 OF 2)

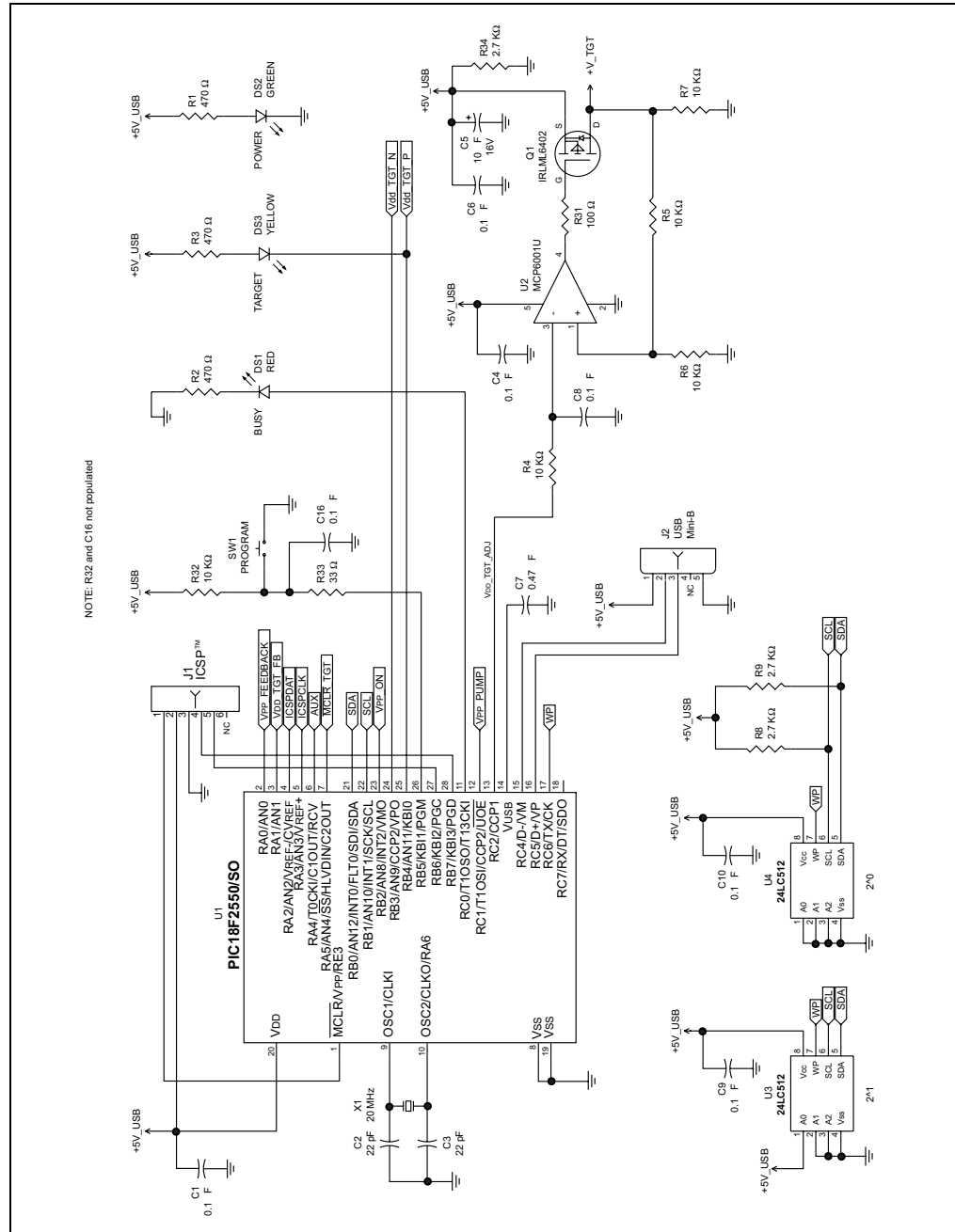

PICKit™ 2 MCU Programmer User's Guide

FIGURE A-2: PICKit™ 2 MICROCONTROLLER PROGRAMMER SCHEMATIC DIAGRAM (PAGE 2 OF 2)

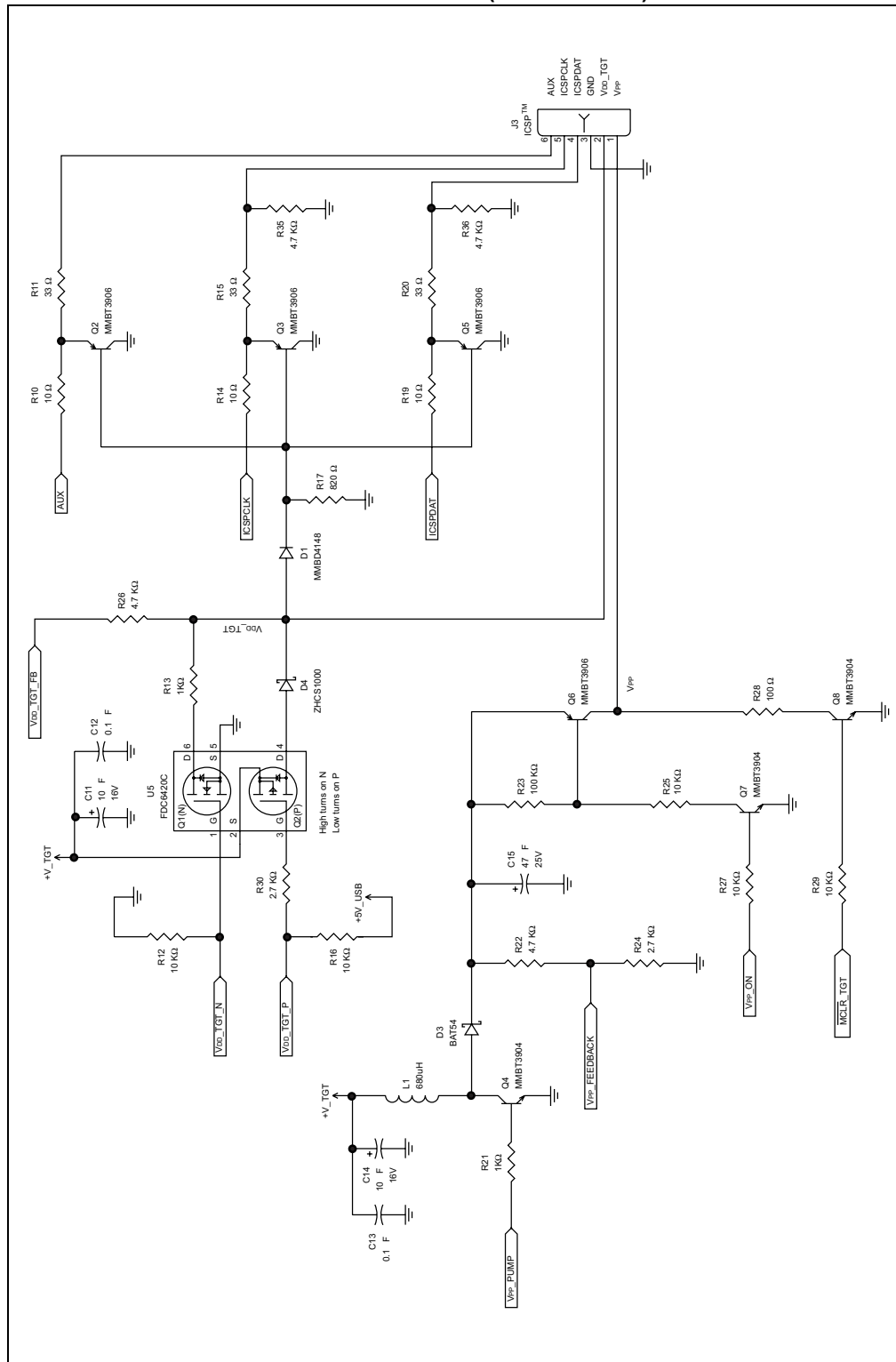

NOTES:



WORLDWIDE SALES AND SERVICE

AMERICAS

Corporate Office
2355 West Chandler Blvd.
Chandler, AZ 85224-6199
Tel: 480-792-7200
Fax: 480-792-7277
Technical Support:
<http://support.microchip.com>
Web Address:
www.microchip.com

Atlanta
Duluth, GA
Tel: 678-957-9614
Fax: 678-957-1455

Boston
Westborough, MA
Tel: 774-760-0087
Fax: 774-760-0088

Chicago
Itasca, IL
Tel: 630-285-0071
Fax: 630-285-0075

Dallas
Addison, TX
Tel: 972-818-7423
Fax: 972-818-2924

Detroit
Farmington Hills, MI
Tel: 248-538-2250
Fax: 248-538-2260

Kokomo
Kokomo, IN
Tel: 765-864-8360
Fax: 765-864-8387

Los Angeles
Mission Viejo, CA
Tel: 949-462-9523
Fax: 949-462-9608

Santa Clara
Santa Clara, CA
Tel: 408-961-6444
Fax: 408-961-6445

Toronto
Mississauga, Ontario,
Canada
Tel: 905-673-0699
Fax: 905-673-6509

ASIA/PACIFIC

Asia Pacific Office
Suites 3707-14, 37th Floor
Tower 6, The Gateway
Harbour City, Kowloon
Hong Kong
Tel: 852-2401-1200
Fax: 852-2401-3431

Australia - Sydney
Tel: 61-2-9868-6733
Fax: 61-2-9868-6755

China - Beijing
Tel: 86-10-8528-2100
Fax: 86-10-8528-2104

China - Chengdu
Tel: 86-28-8665-5511
Fax: 86-28-8665-7889

China - Fuzhou
Tel: 86-591-8750-3506
Fax: 86-591-8750-3521

China - Hong Kong SAR
Tel: 852-2401-1200
Fax: 852-2401-3431

China - Qingdao
Tel: 86-532-8502-7355
Fax: 86-532-8502-7205

China - Shanghai
Tel: 86-21-5407-5533
Fax: 86-21-5407-5066

China - Shenyang
Tel: 86-24-2334-2829
Fax: 86-24-2334-2393

China - Shenzhen
Tel: 86-755-8203-2660
Fax: 86-755-8203-1760

China - Shunde
Tel: 86-757-2839-5507
Fax: 86-757-2839-5571

China - Wuhan
Tel: 86-27-5980-5300
Fax: 86-27-5980-5118

China - Xian
Tel: 86-29-8833-7252
Fax: 86-29-8833-7256

ASIA/PACIFIC

India - Bangalore
Tel: 91-80-4182-8400
Fax: 91-80-4182-8422

India - New Delhi
Tel: 91-11-4160-8631
Fax: 91-11-4160-8632

India - Pune
Tel: 91-20-2566-1512
Fax: 91-20-2566-1513

Japan - Yokohama
Tel: 81-45-471- 6166
Fax: 81-45-471-6122

Korea - Daegu
Tel: 82-53-744-4301
Fax: 82-53-744-4302

Korea - Seoul
Tel: 82-2-554-7200
Fax: 82-2-558-5932 or
82-2-558-5934

Malaysia - Penang
Tel: 60-4-646-8870
Fax: 60-4-646-5086

Philippines - Manila
Tel: 63-2-634-9065
Fax: 63-2-634-9069

Singapore
Tel: 65-6334-8870
Fax: 65-6334-8850

Taiwan - Hsin Chu
Tel: 886-3-572-9526
Fax: 886-3-572-6459

Taiwan - Kaohsiung
Tel: 886-7-536-4818
Fax: 886-7-536-4803

Taiwan - Taipei
Tel: 886-2-2500-6610
Fax: 886-2-2508-0102

Thailand - Bangkok
Tel: 66-2-694-1351
Fax: 66-2-694-1350

EUROPE

Austria - Wels
Tel: 43-7242-2244-39
Fax: 43-7242-2244-393

Denmark - Copenhagen
Tel: 45-4450-2828
Fax: 45-4485-2829

France - Paris
Tel: 33-1-69-53-63-20
Fax: 33-1-69-30-90-79

Germany - Munich
Tel: 49-89-627-144-0
Fax: 49-89-627-144-44

Italy - Milan
Tel: 39-0331-742611
Fax: 39-0331-466781

Netherlands - Drunen
Tel: 31-416-690399
Fax: 31-416-690340

Spain - Madrid
Tel: 34-91-708-08-90
Fax: 34-91-708-08-91

UK - Wokingham
Tel: 44-118-921-5869
Fax: 44-118-921-5820